

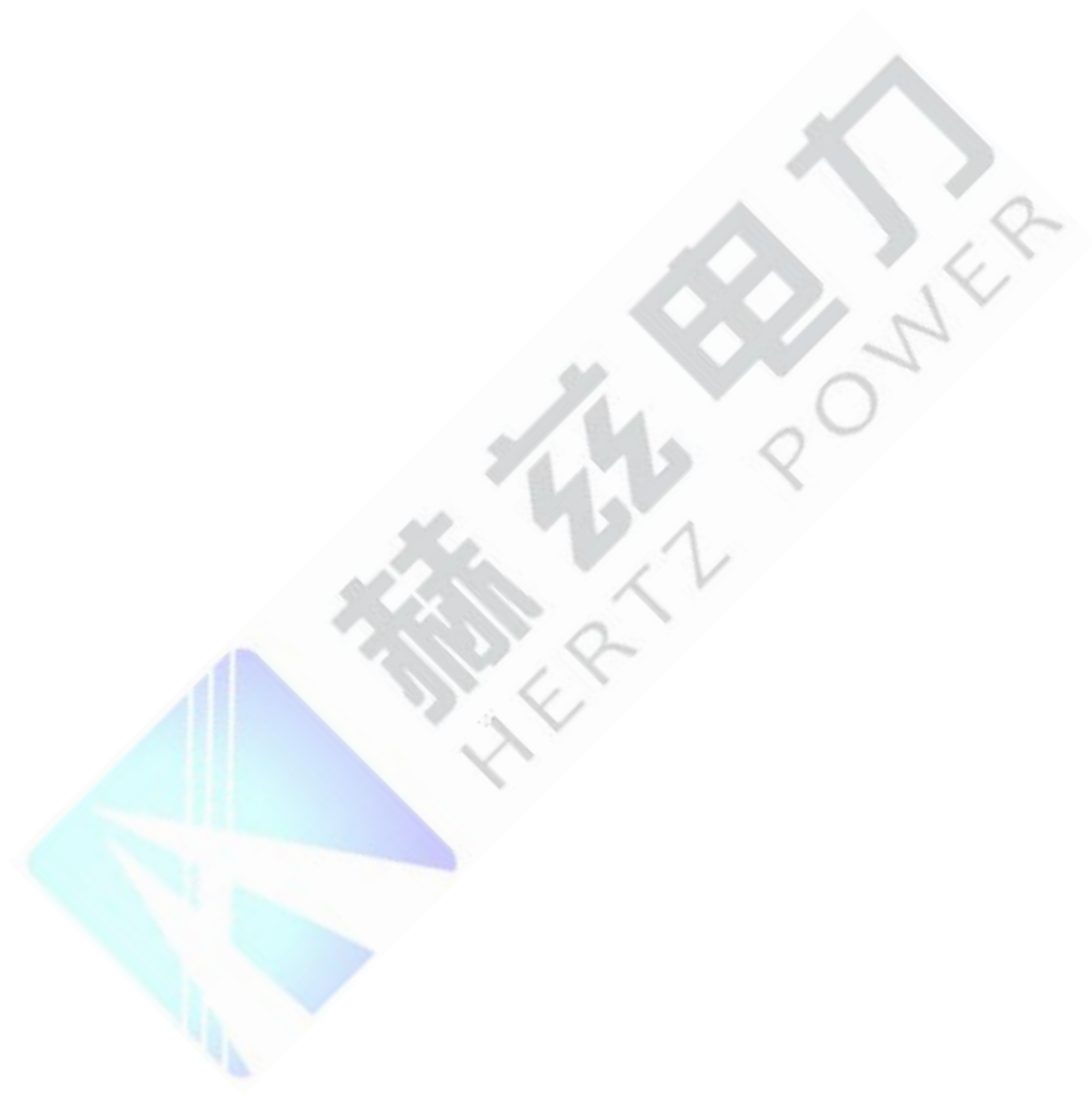

赫兹电力

产品宗旨：技术领先，质量可靠，轻便易用

服务宗旨：快速响应，时间到满意，超过期





产品宗旨：技术领先，质量可靠，轻便易用
服务宗旨：快速响应，客户满意，超过期望

赫兹电力
HERTZ POWER

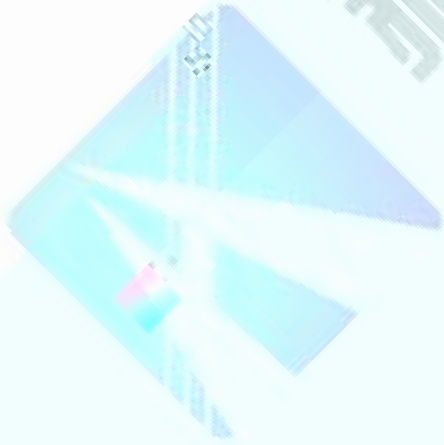



产品宗旨：技术领先，质量可靠，轻便易用

服务宗旨：快速响应，**客户**到满意，**超过期**



--	--

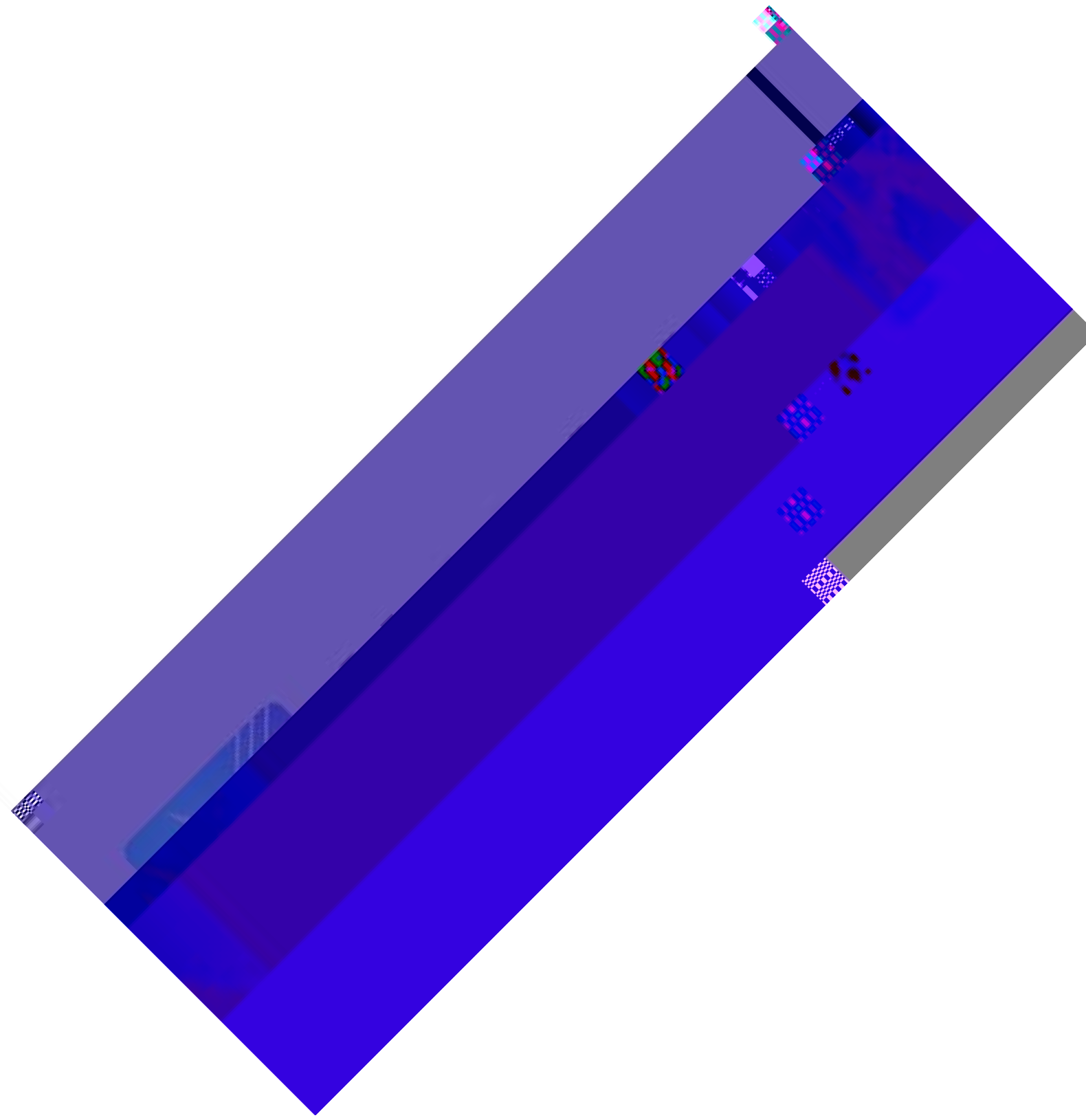

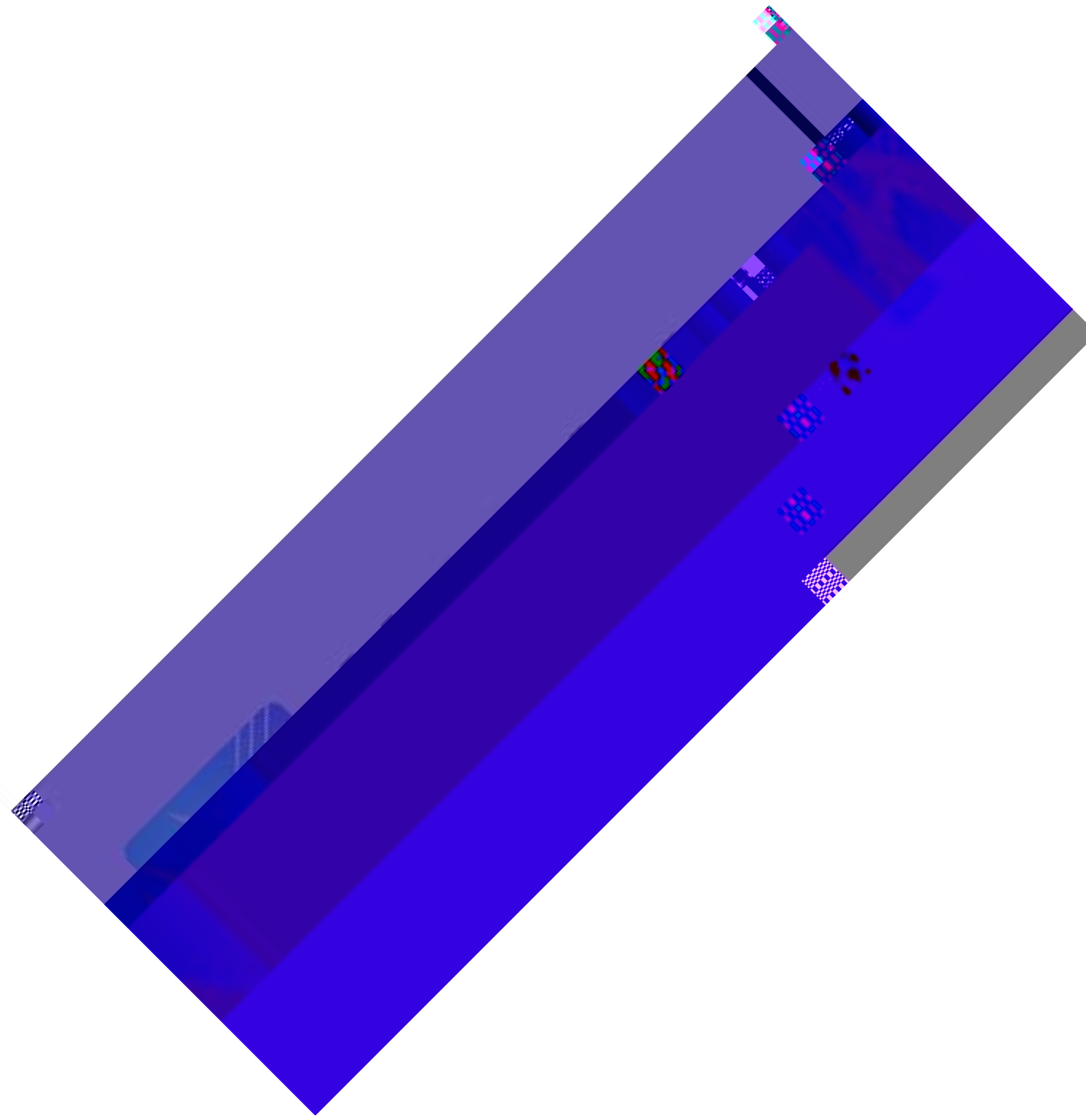



产品宗旨：技 先，质量可靠，轻便易用
服务宗旨：快 应，到满意，超过期

赫电

IBR

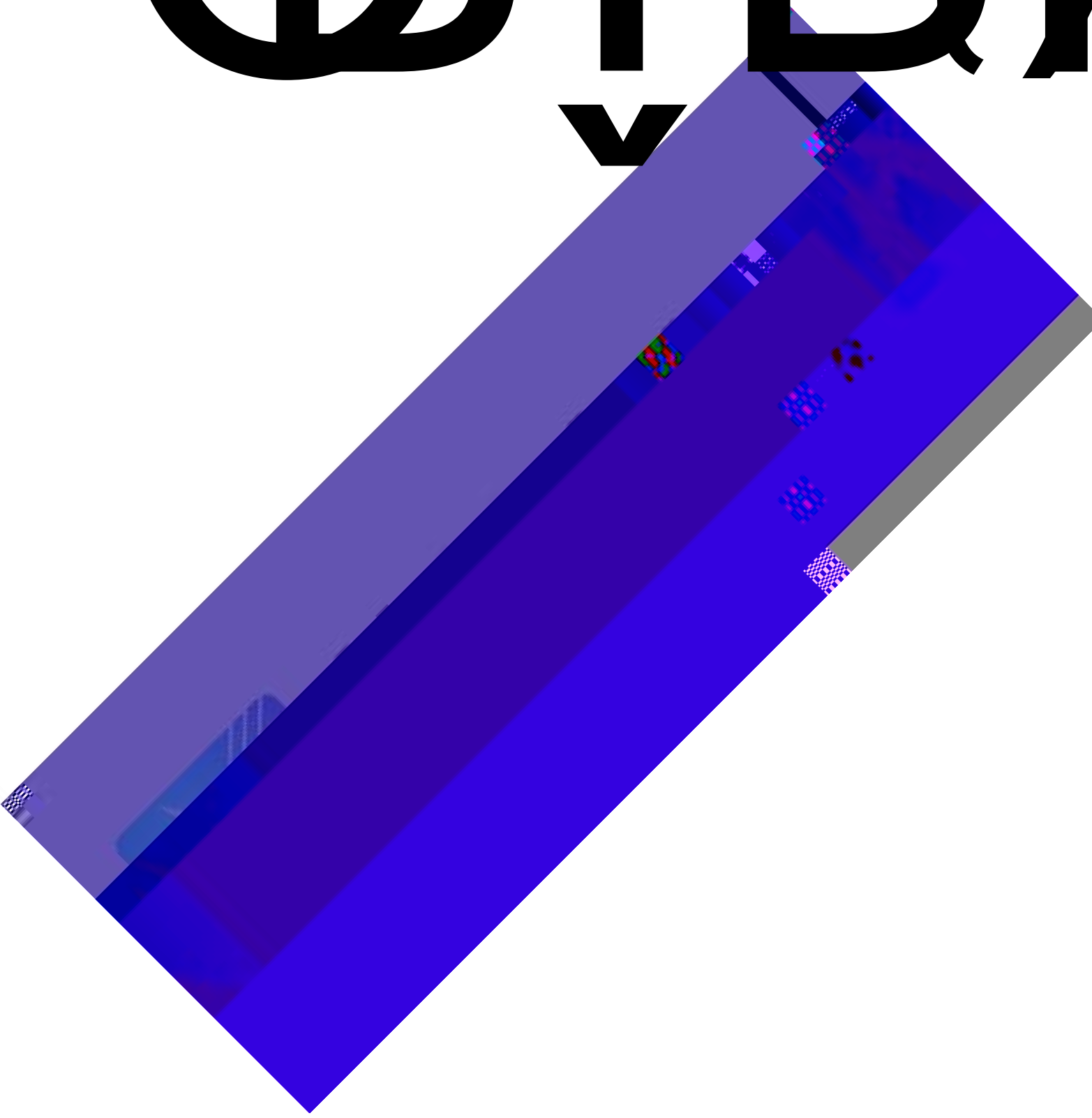

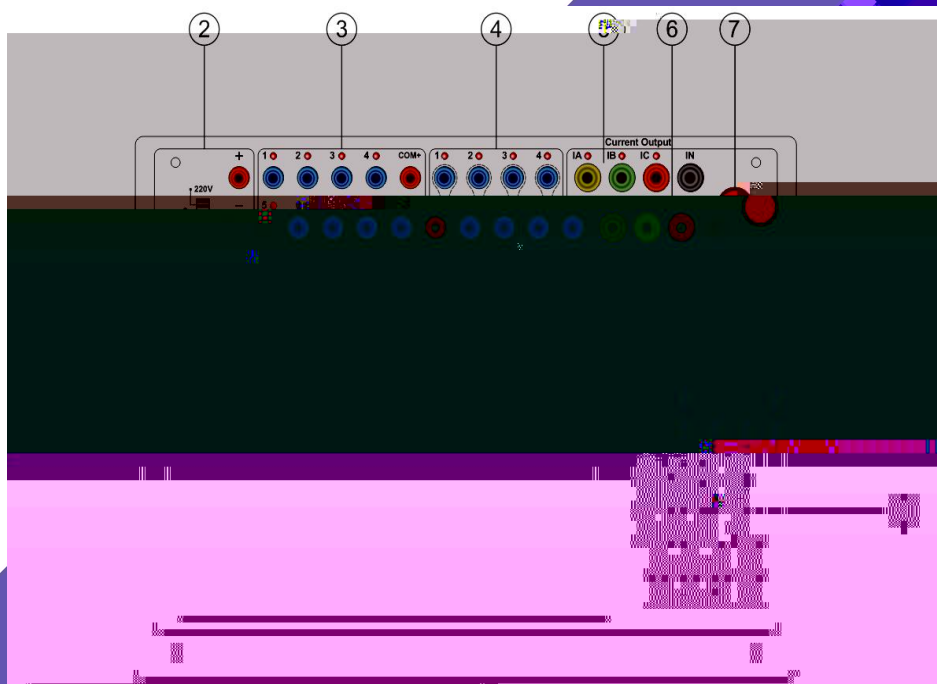

V U

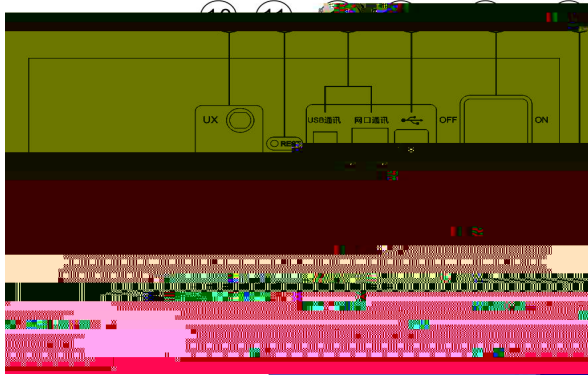

产品宗旨：技术领先，质量可靠，轻便易用

服务宗旨：快速响应，客户满意，超过期望

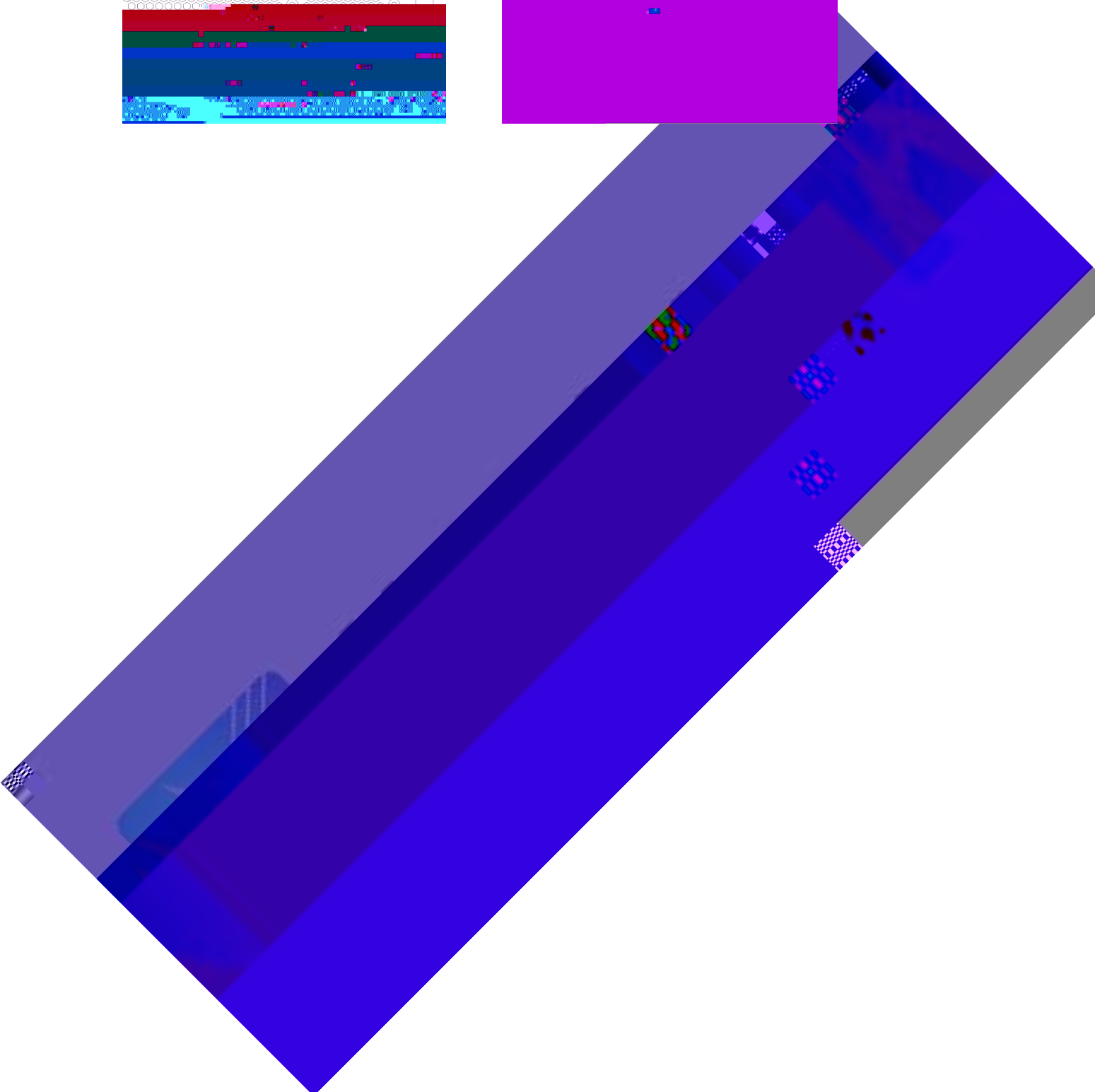
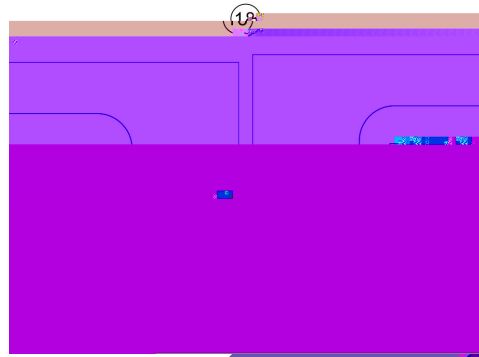
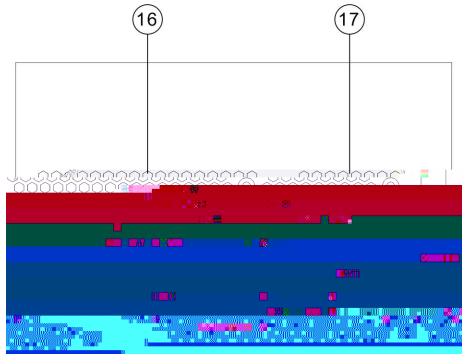

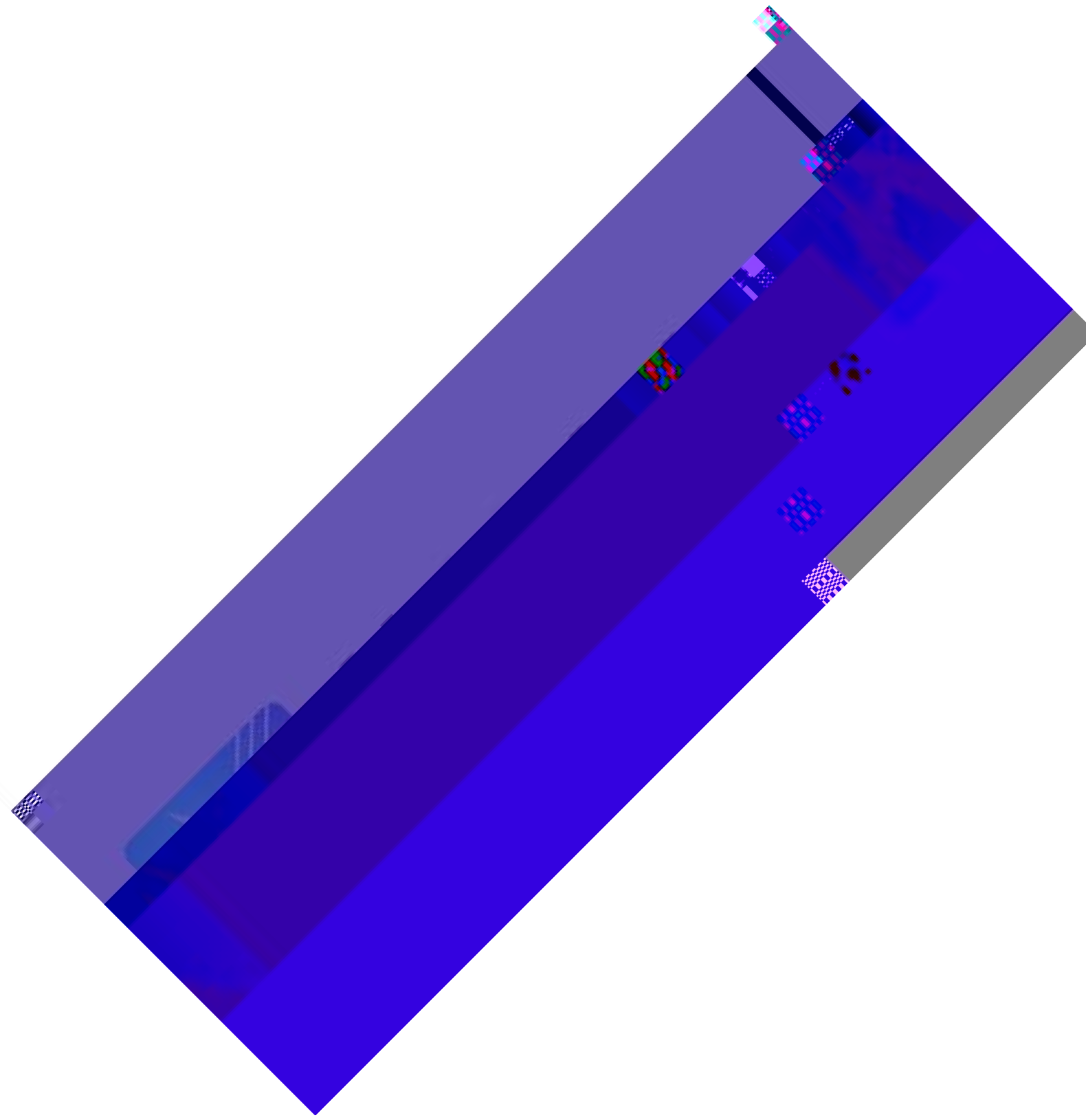



TM•õ"@öĐ'•

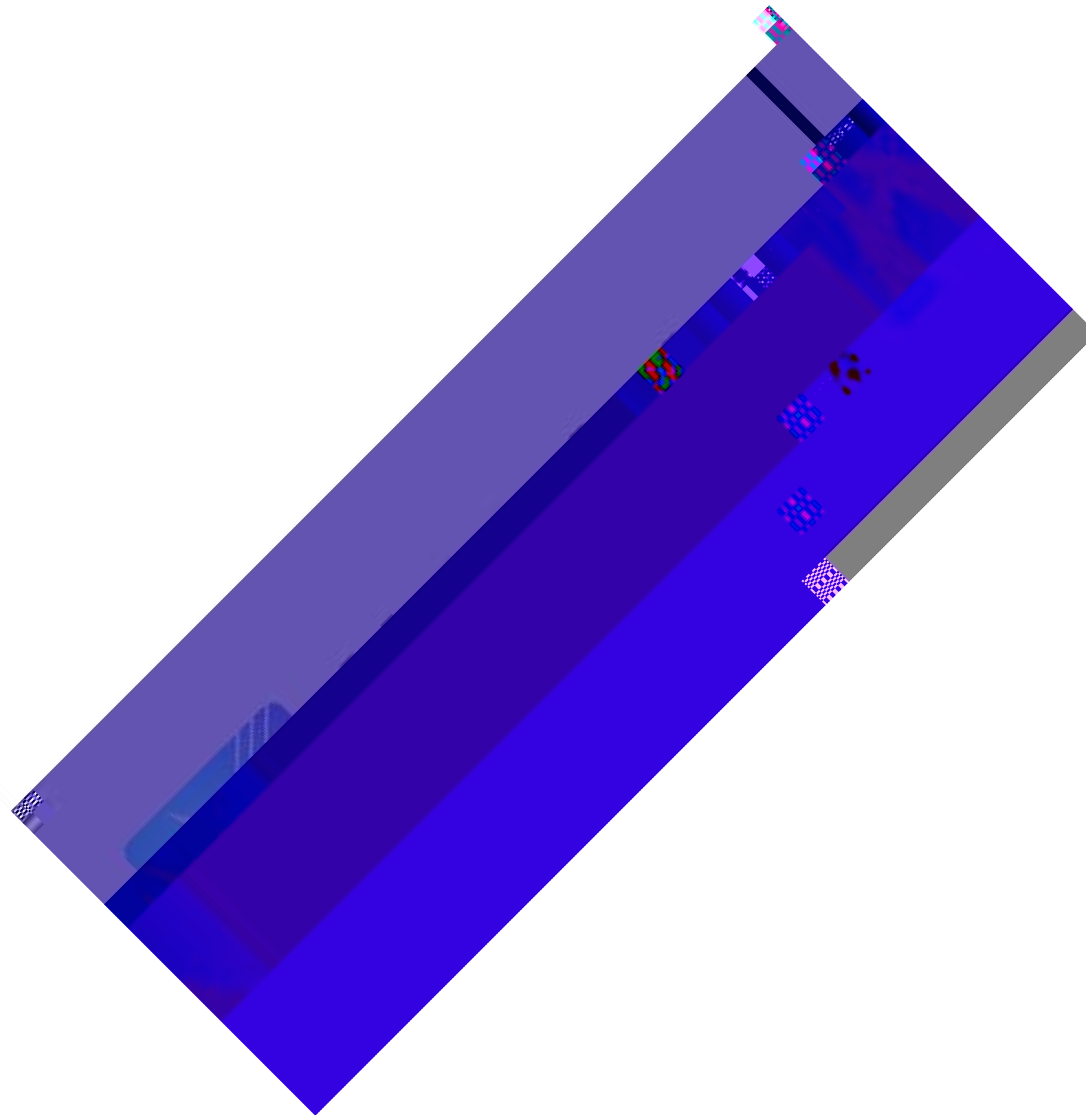

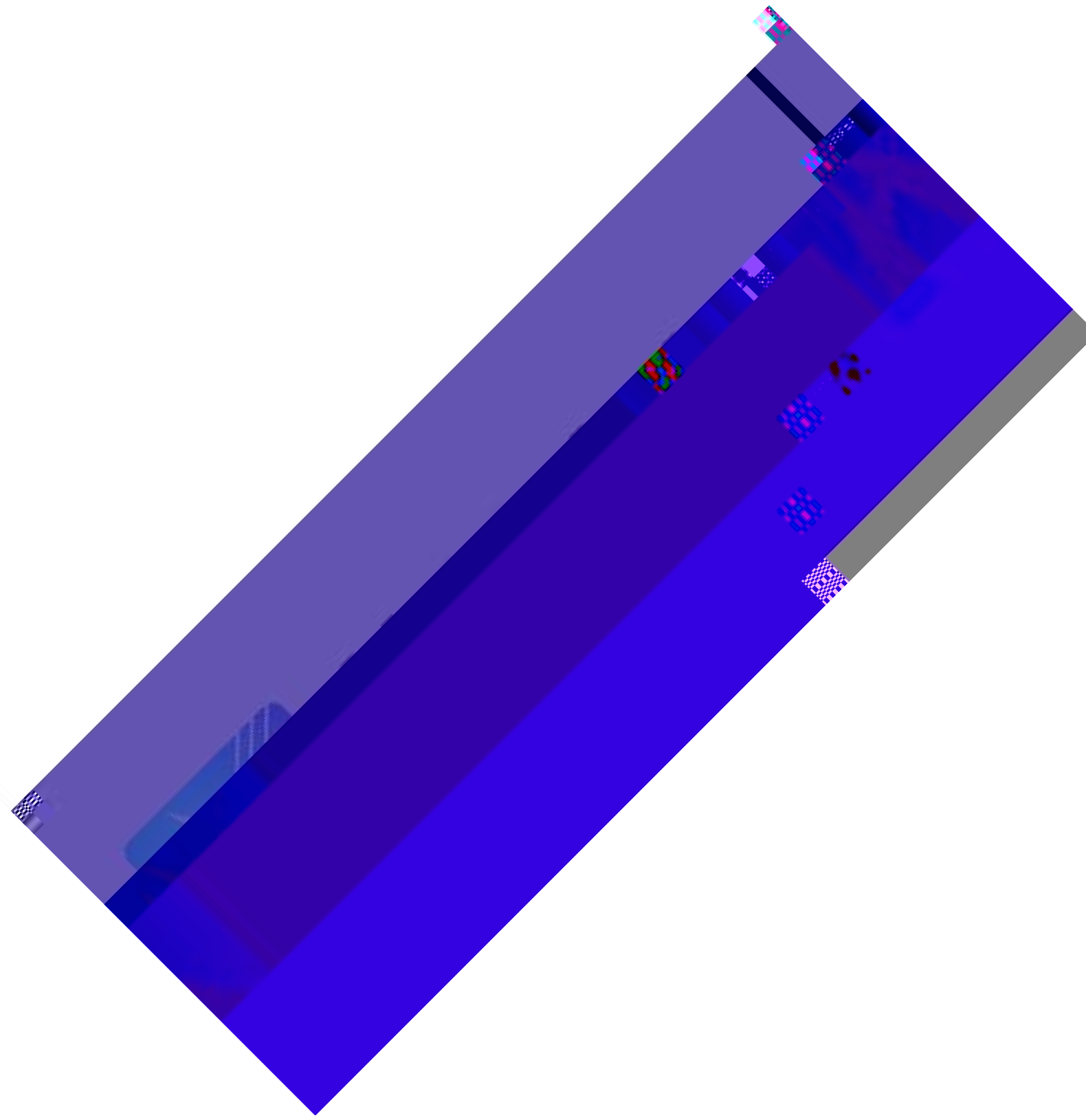

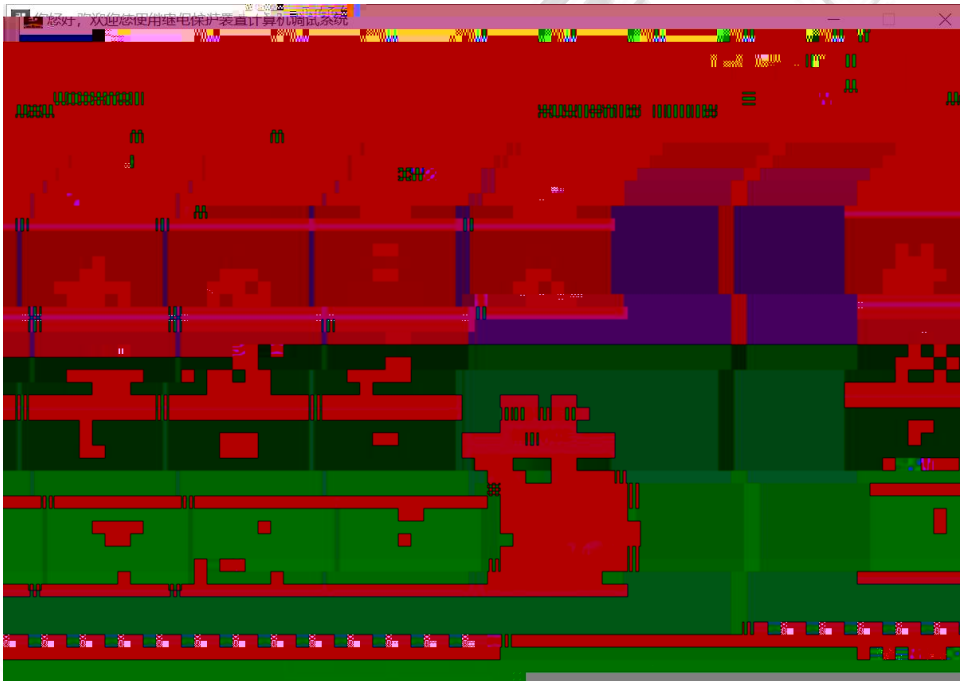



产品宗旨：技术领先，质量可靠，轻便易用
服务宗旨：快速响应，客户到满意，超过期



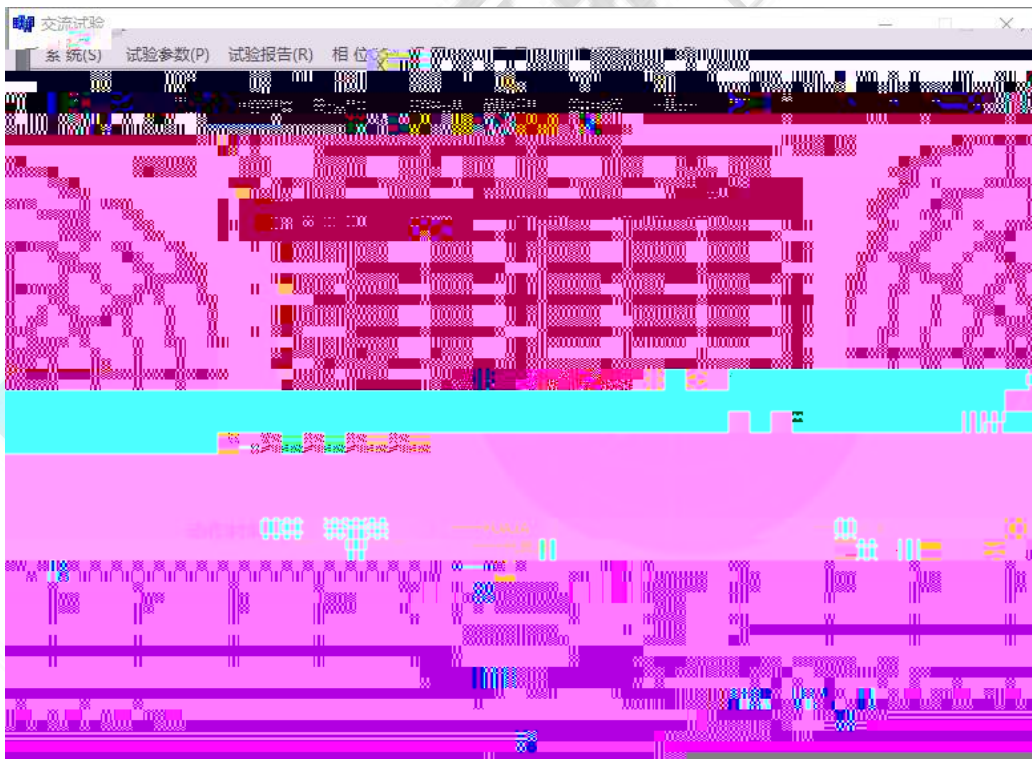
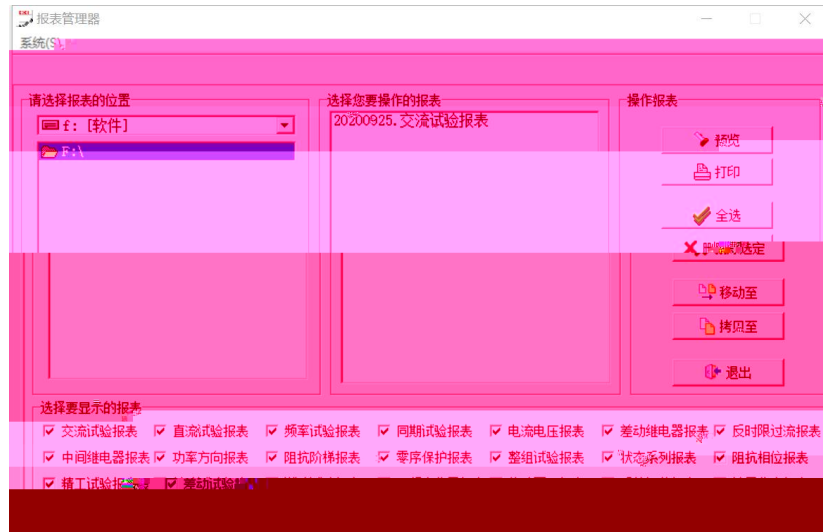



产品宗旨：技术领先，质量可靠，轻便易用
服务宗旨：快速响应，客户到满意，超过期



赫兹电力
HERTZ POWER

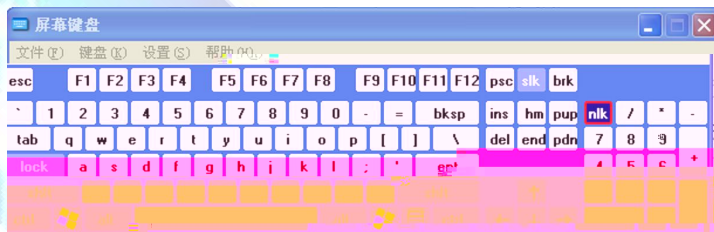



赫兹电力

产品宗旨：技术领先，质量可靠，轻便易用

服务宗旨：快速响应，客户满意，超过期望

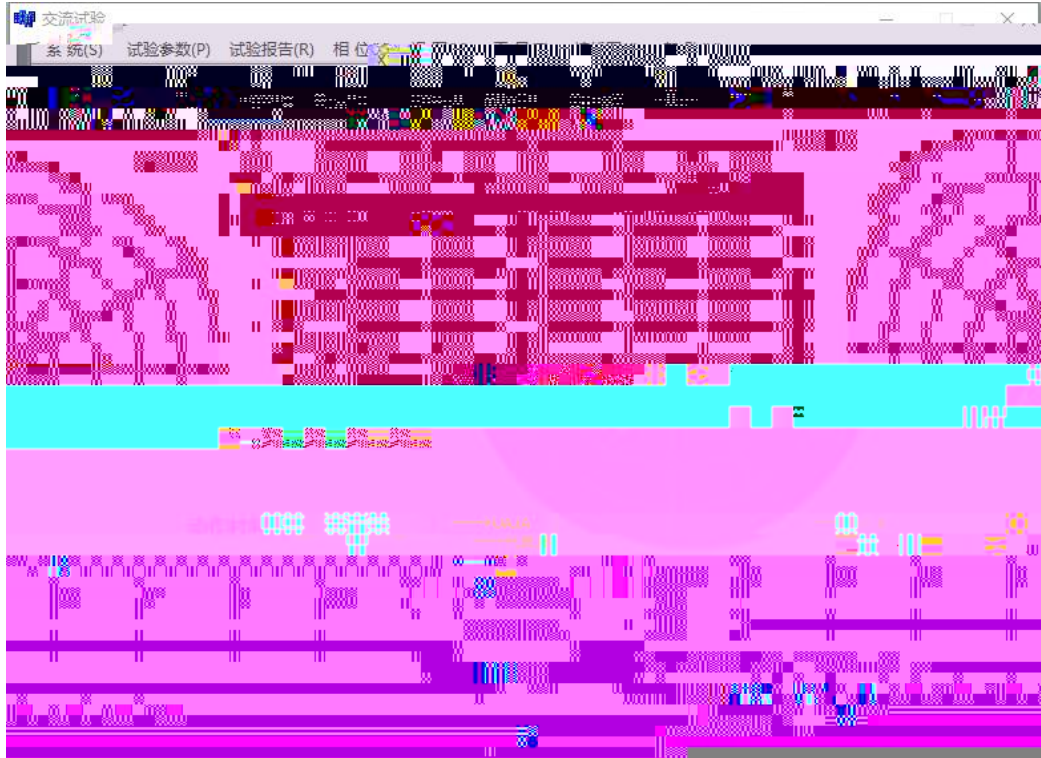



产品宗旨：技术领先，质量可靠，轻便易用
服务宗旨：快速响应，客户到满意，超过期



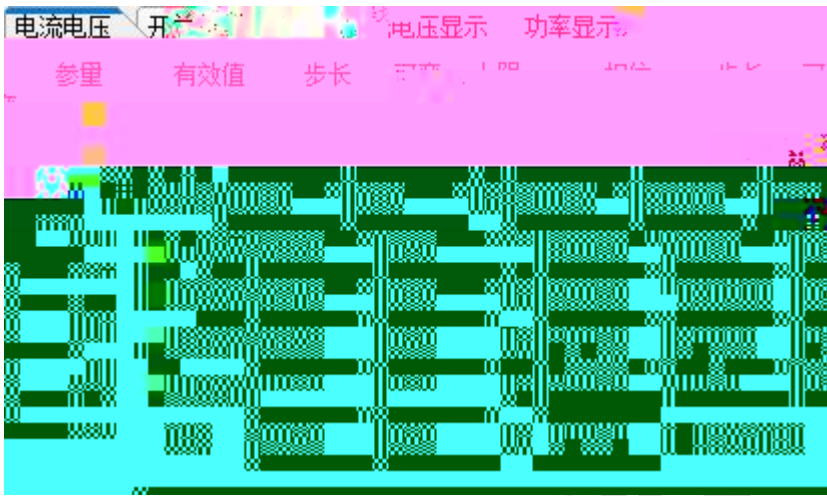

y#; (#;

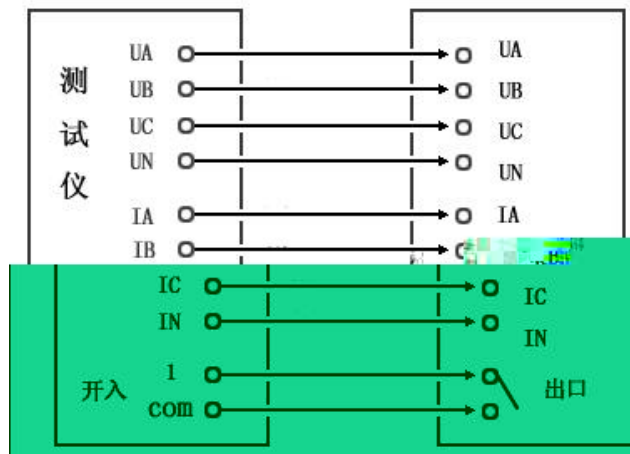

HERZ

POWER

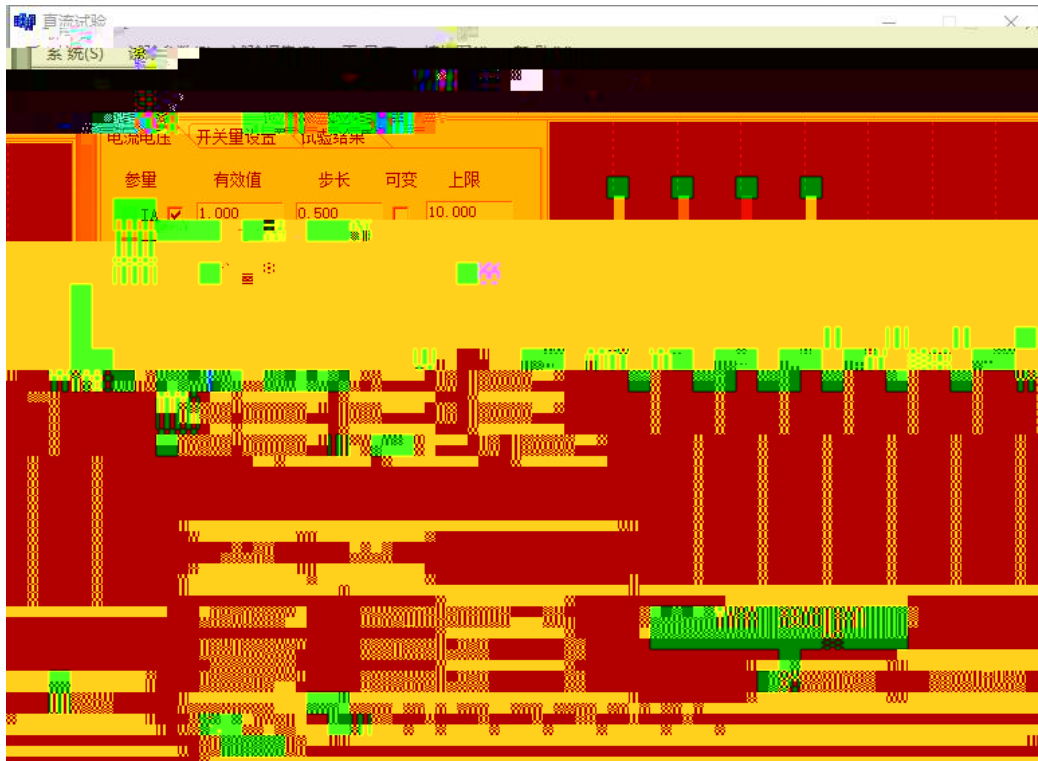

赫兹
HERTZ POWER



赫兹电力

产品宗旨:

领先, 可靠, 轻便易用

服务宗旨:

响应, 到满意, 超过期



赫兹电力
HERTZ POWER

2024年. @. 公司



à
È ž ð
> à È • È ž
07

2024年. @. 公司

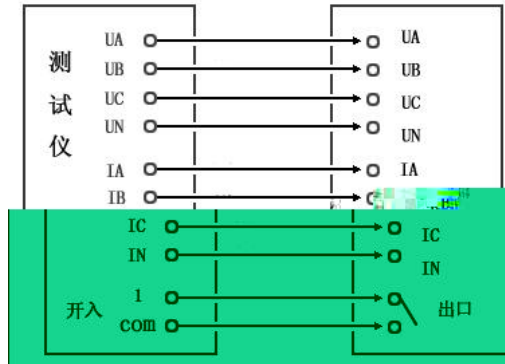



产品宗旨：技术领先，质量可靠，轻便易用
服务宗旨：快速响应，**客户**到满意，**超过期**





产品宗旨：技术领先，质量可靠，轻便易用
服务宗旨：快速响应，**客户**到满意，**超过期**





产品宗旨：技术领先，质量可靠，轻便易用
服务宗旨：快速响应，**客户**到满意，**超过期**



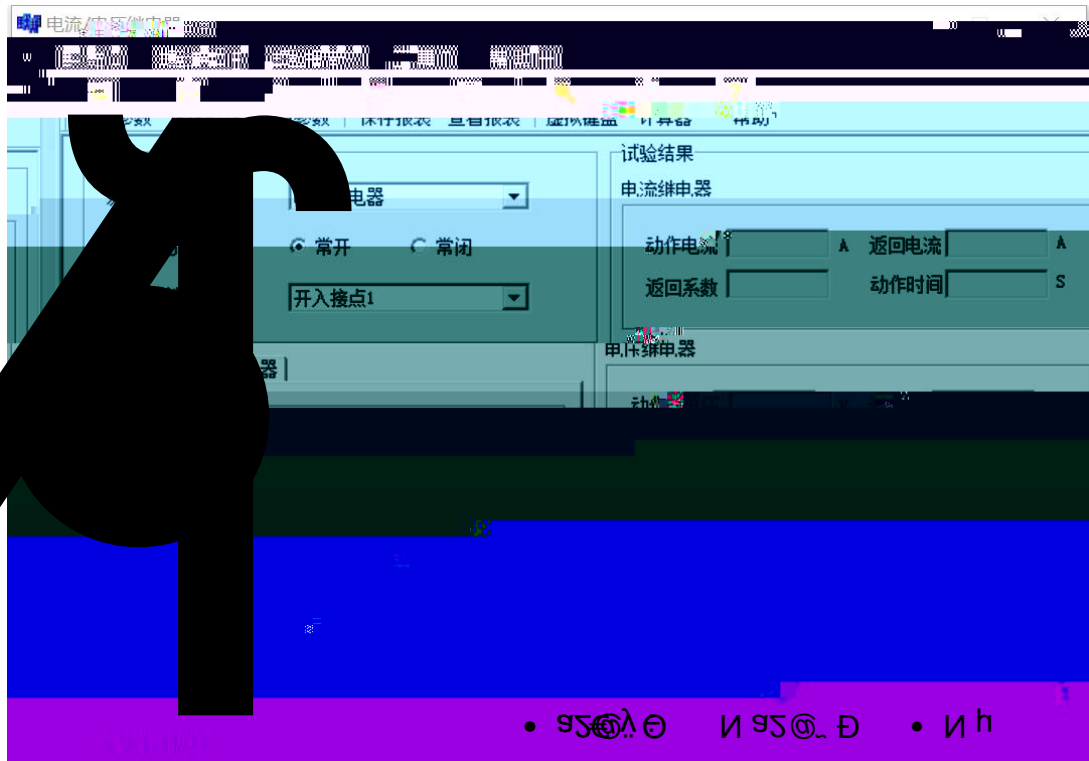

赫兹电力
HERTZ POWER



序号	地址	动作Id
1	1.000	
2	2.000	
3	3.000	
4	4.000	
5	5.000	
6	6.000	
7	7.000	
8	8.000	
9	9.000	
10	10.000	

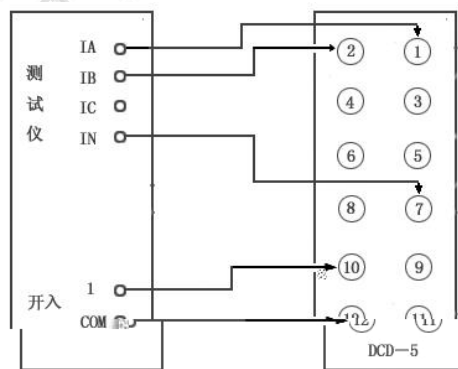
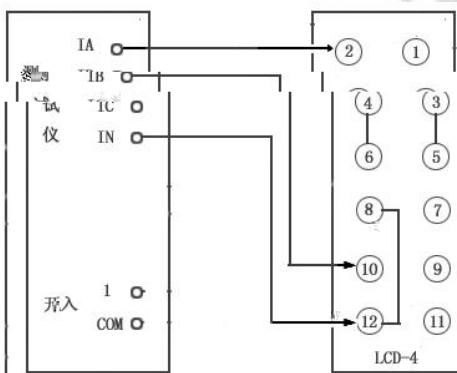

反时限过流继电器

系统(S) 试验参数(P) 试验报告(R) 工具(T) 接线图(Z) 帮助(H)

打开参数 保存参数 缺省参数 保存报表 查看报表 虚拟键盘 计算器 帮助

测试参数

输出相别(A) IA:

开入量通道 接点1:

开入量方式 常开

额定电压 220V

测量点数 10

额定电流 1.000

曲线图

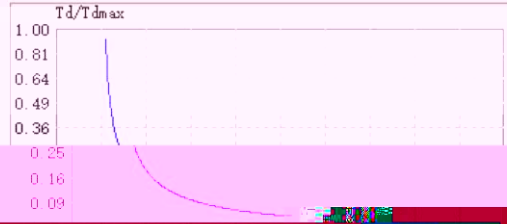

曲线号	额定电流	整定电流	动作时间
1	5.000	5.500	
2	5.000	6.000	
3	5.000	7.000	
4	5.000	8.000	
5	5.000	9.000	
6	5.000	10.000	
7	5.000	11.000	

曲线选择

类型 一般反时限

公式 $t=0.14c/[(I/I_e)^{0.02}-1]$

c= 0.200

根据c计算Tdmax= 14.675

开始试验 停止试验



赫兹电力
HERTZ POWER



产品宗旨：技术领先，质量可靠，轻便易用
服务宗旨：快速响应，**客户**到满意，**超过期**





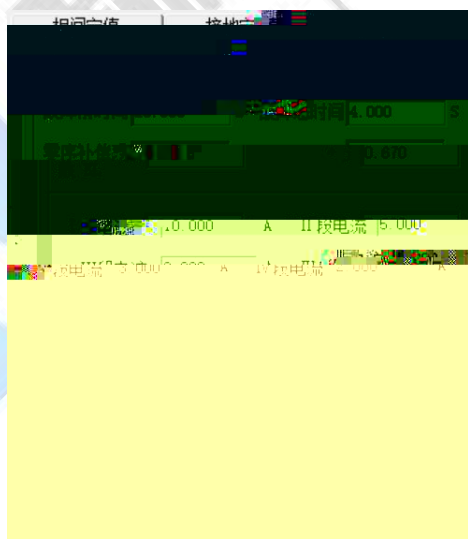
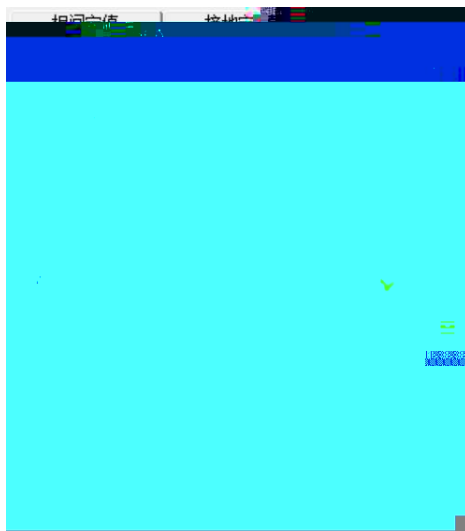

赫兹电力
HERTZ POWER

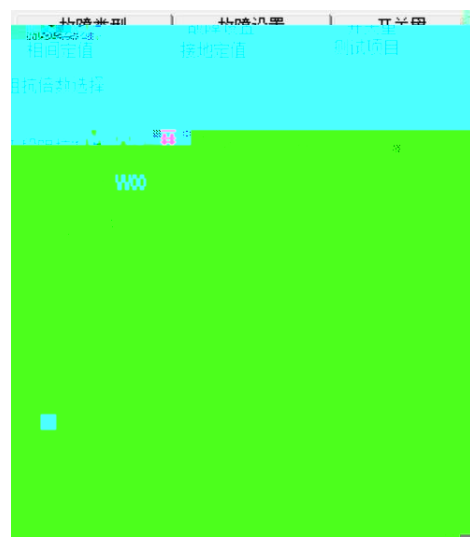

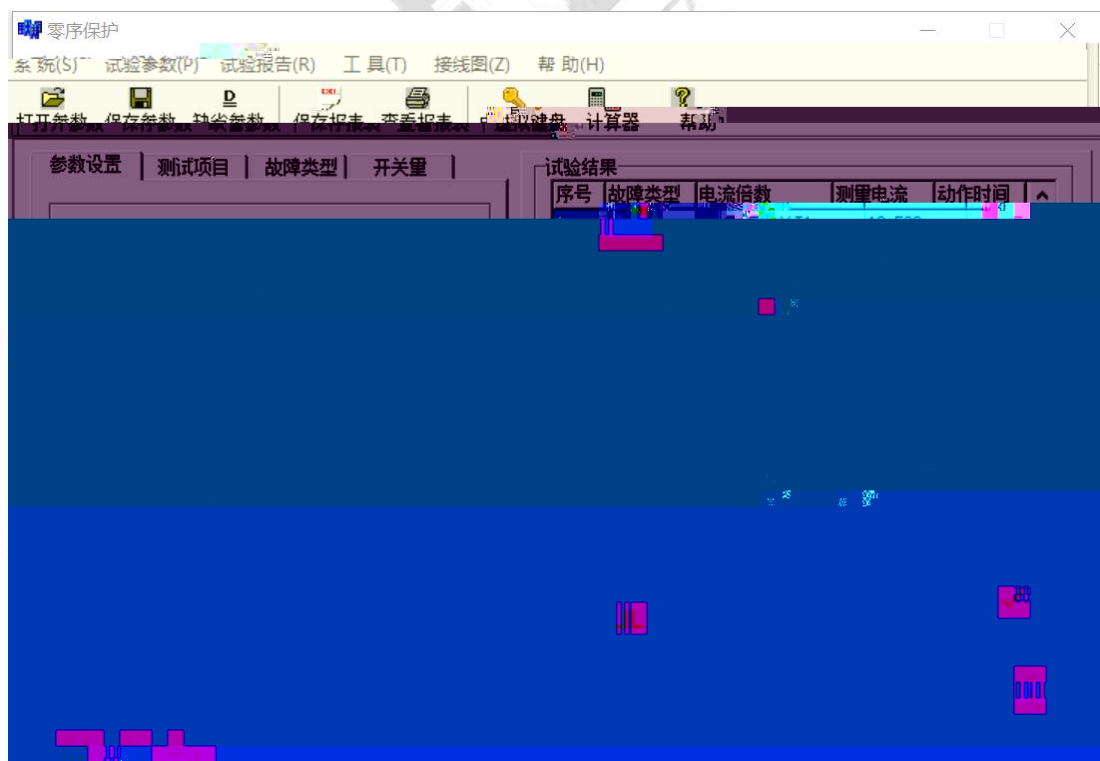
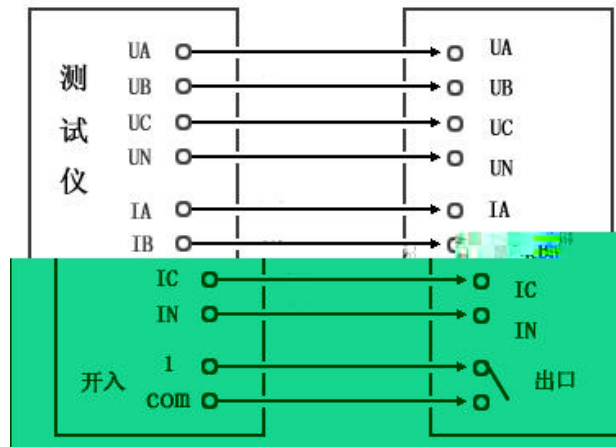



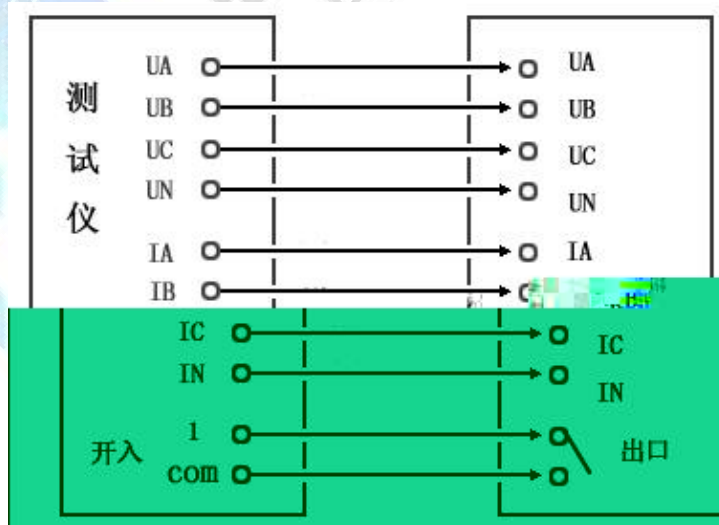
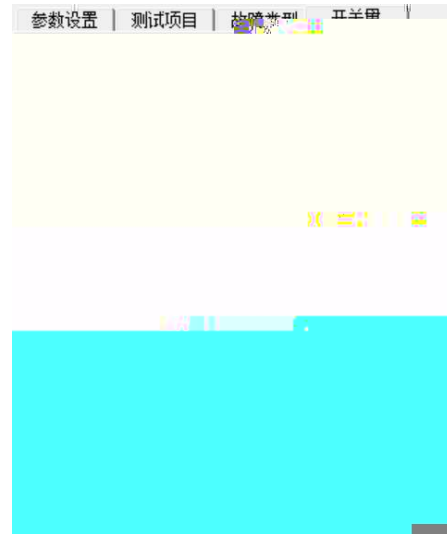
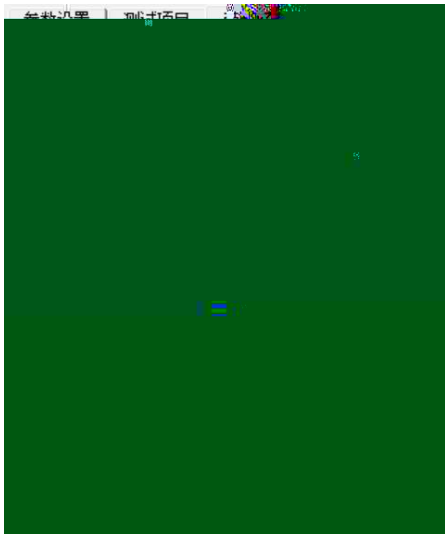

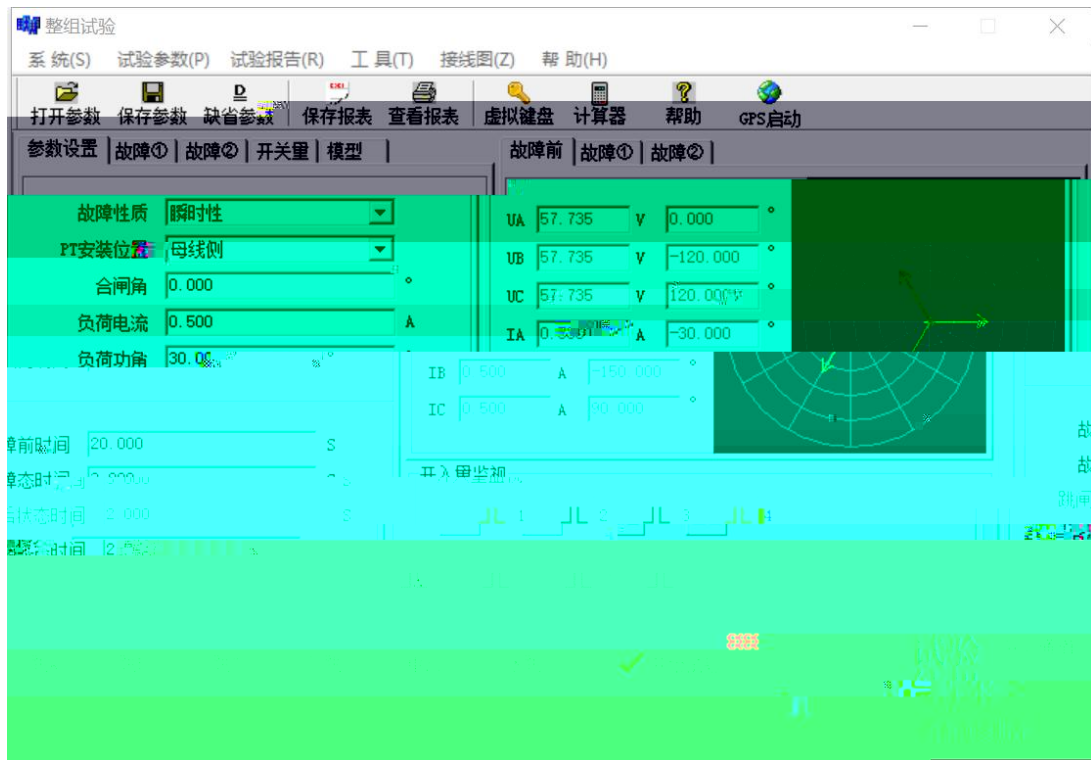



产品宗旨：技术领先，质量可靠，轻便易用
服务宗旨：快速响应，**客户**到满意，**超过期**



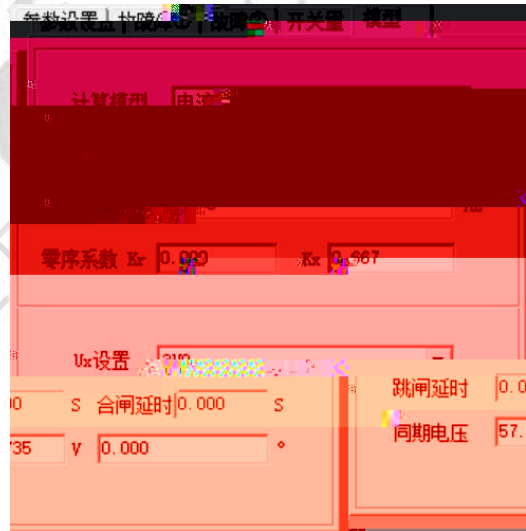
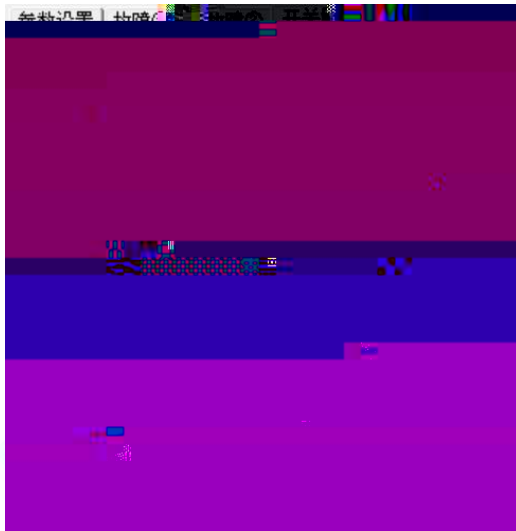



产品宗旨：技术领先，质量可靠，轻便易用
服务宗旨：快速响应，**客户**到满意，**超过期**





赫兹电力

产品宗旨：技术领先，质量可靠，轻便易用

服务宗旨：快速响应，客户到满意，超过期

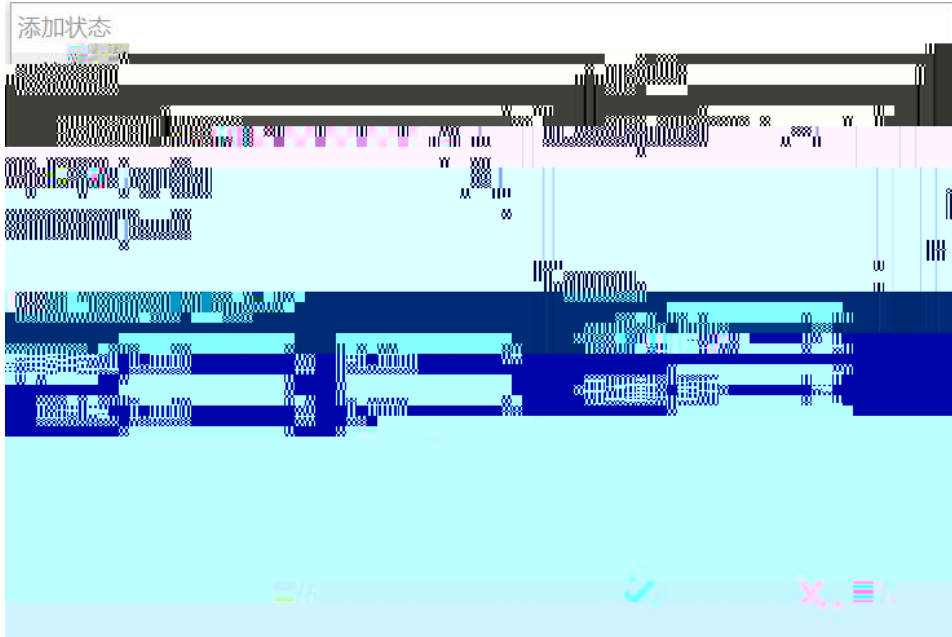

赫兹
HERTZ POWER

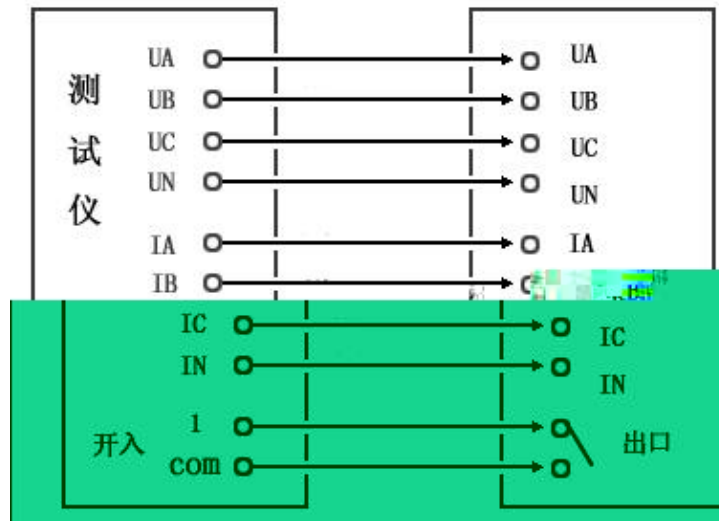



产品宗旨：技术领先，质量可靠，轻便易用
服务宗旨：快速响应，**客户**到满意，**超过期**



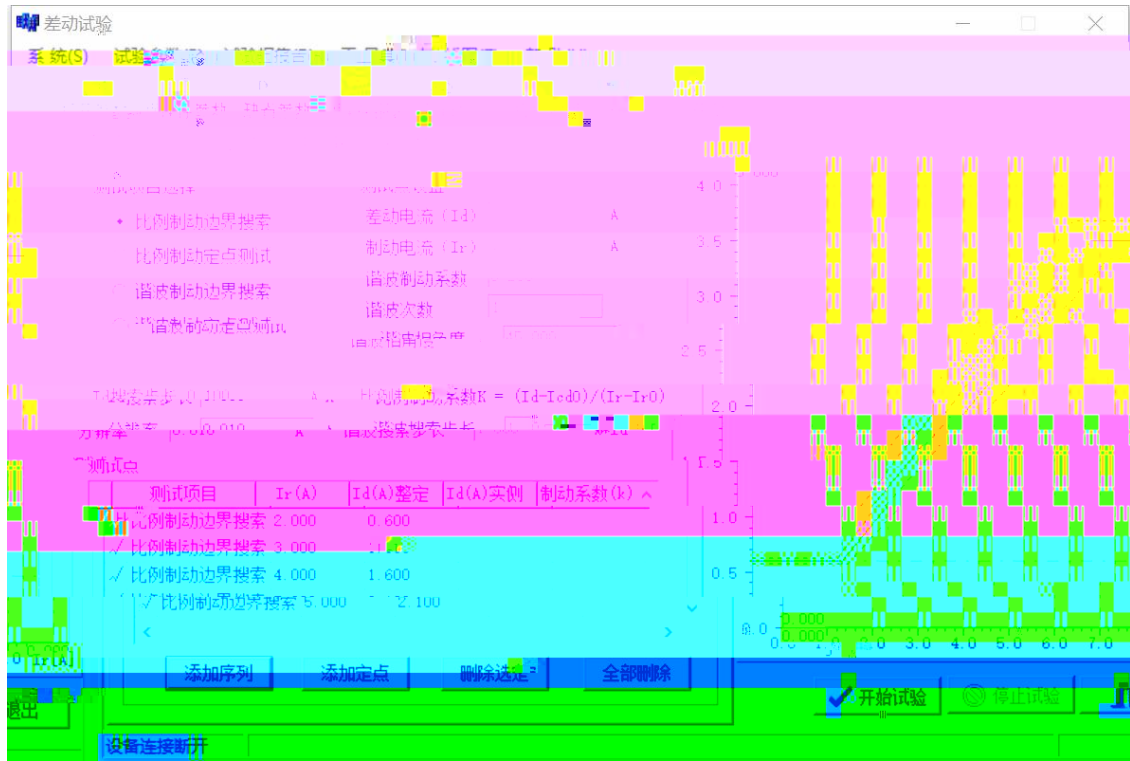

赫兹
HERTZ



产品宗旨：技术领先，质量可靠，轻便易用
服务宗旨：快速响应，客户到满意，超过期





赫兹电力
HERTZ POWER

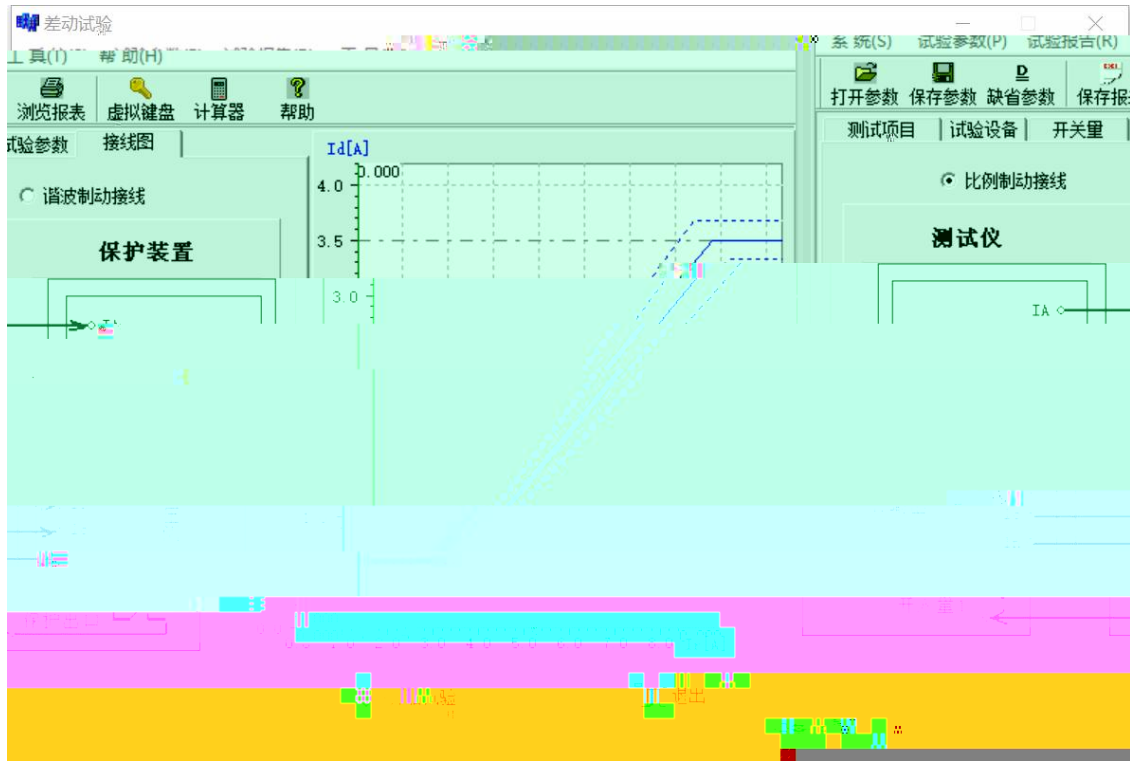

赫兹电力
HERTZ POWER

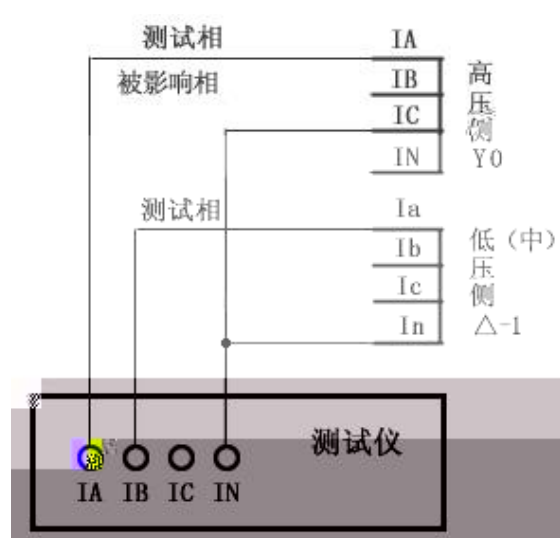
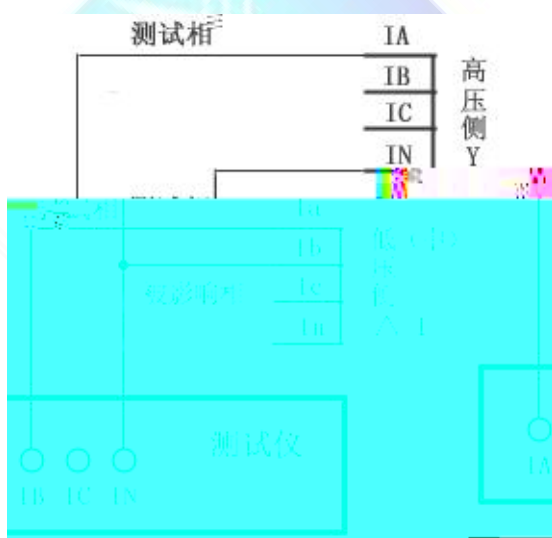
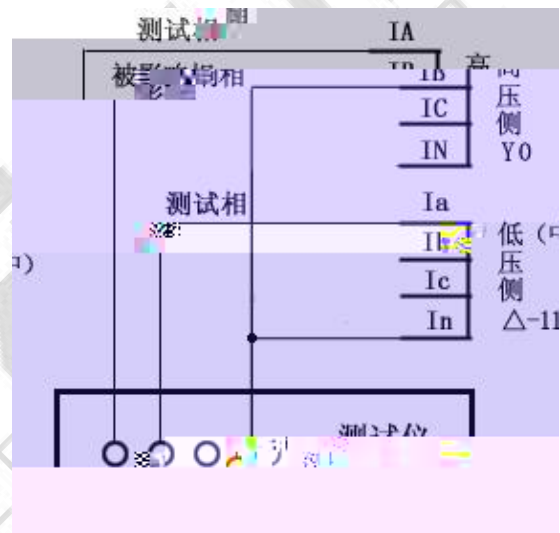
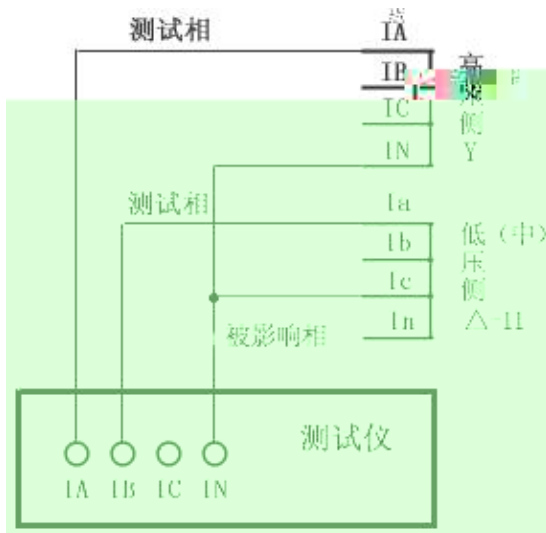
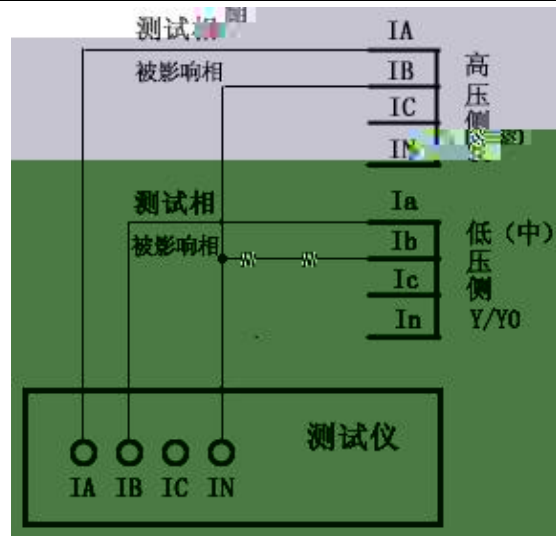
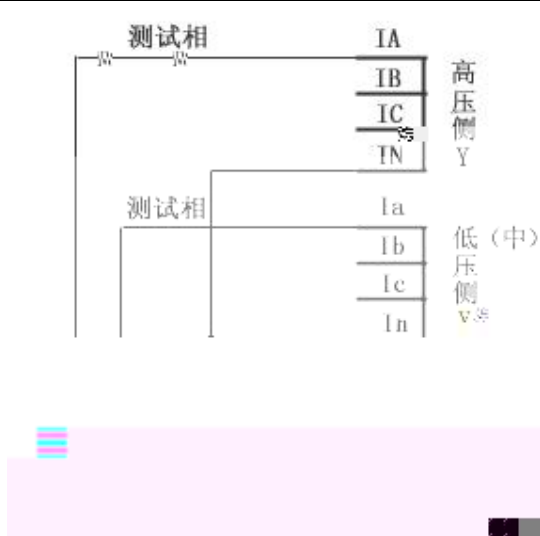

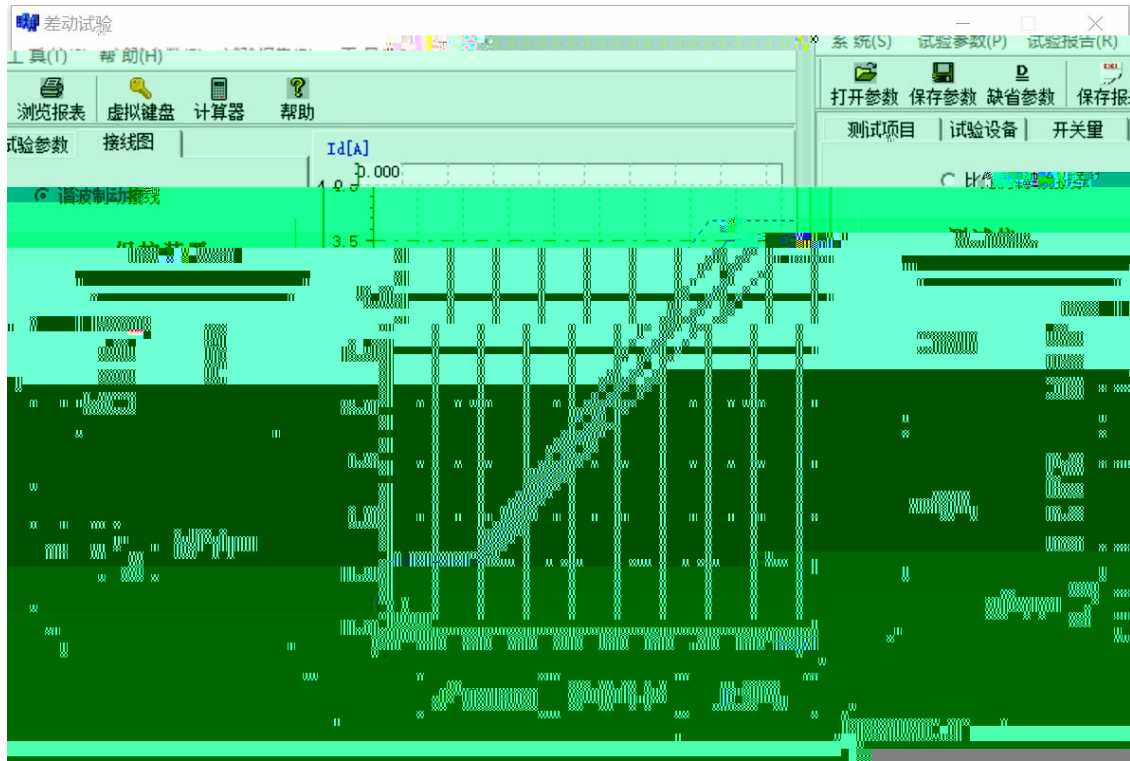

赫兹
HERTZ POWER

比例制动边界搜索

制动电流(Ir)

起始值	2.000	A
终止值	20.000	A
步长	2.000	A
点数	10	

添加 取消

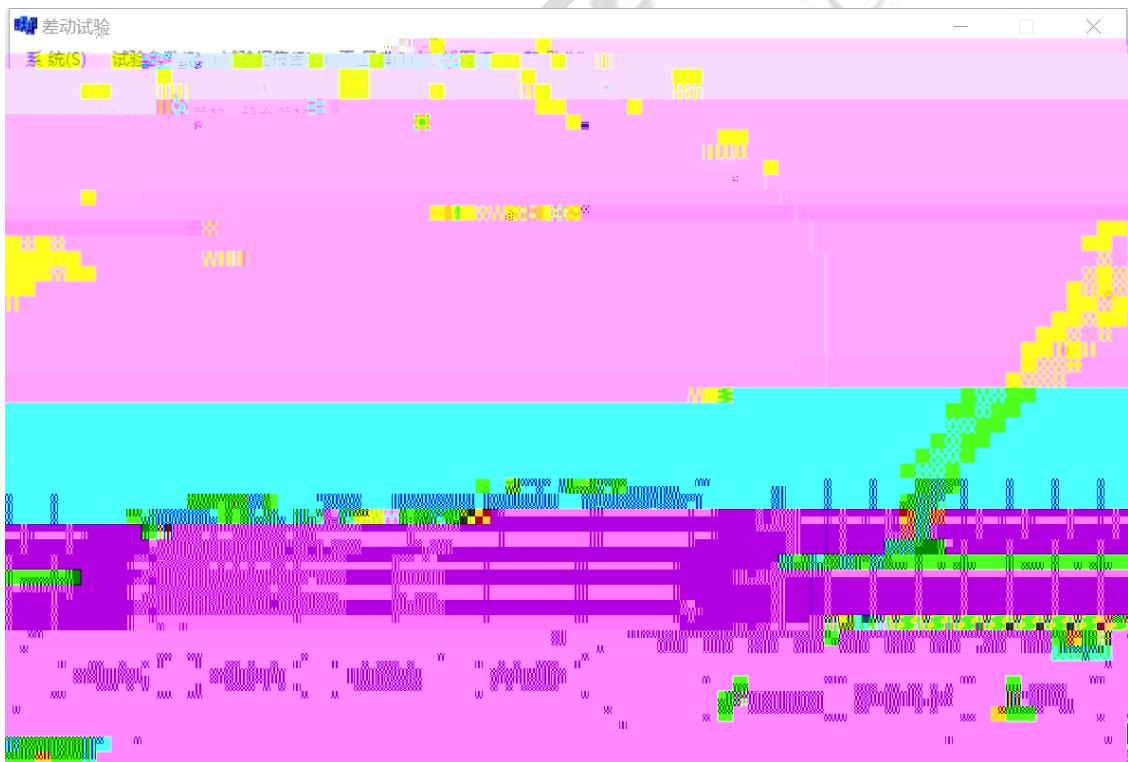

谐波制动边界搜索

差动电流(I_d)

起始值 0.600 A

终止值 3.500 A

步长 1.000 A

点数 3

添加 取消



赫兹电力
HERTZ POWER



赫兹电力
HERTZ POWER

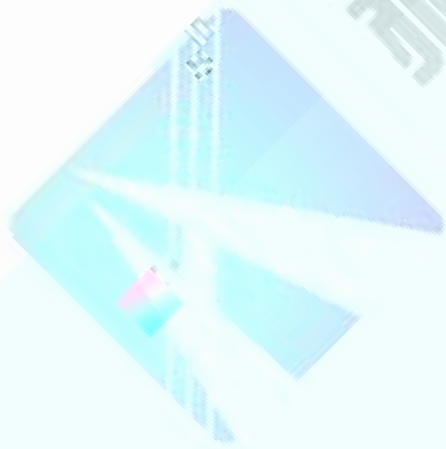



赫兹电力

产品宗旨：技术领先，质量可靠，轻便易用

服务宗旨：快速响应，客户满意，超过期望

赫兹电力
HERTZ POWER

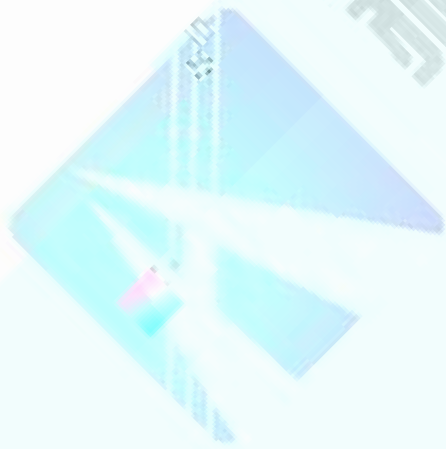



产品宗旨：技术领先，质量可靠，轻便易用
服务宗旨：快速响应，**客户**到满意，**超过期**

赫兹电力
HERTZ POWER

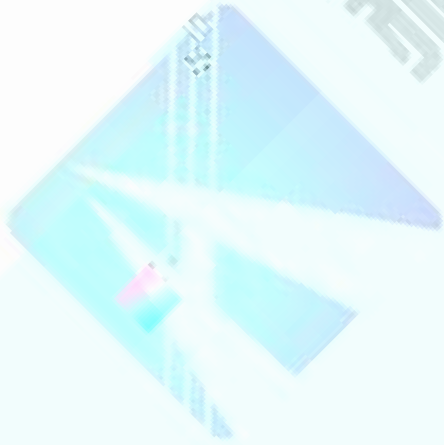

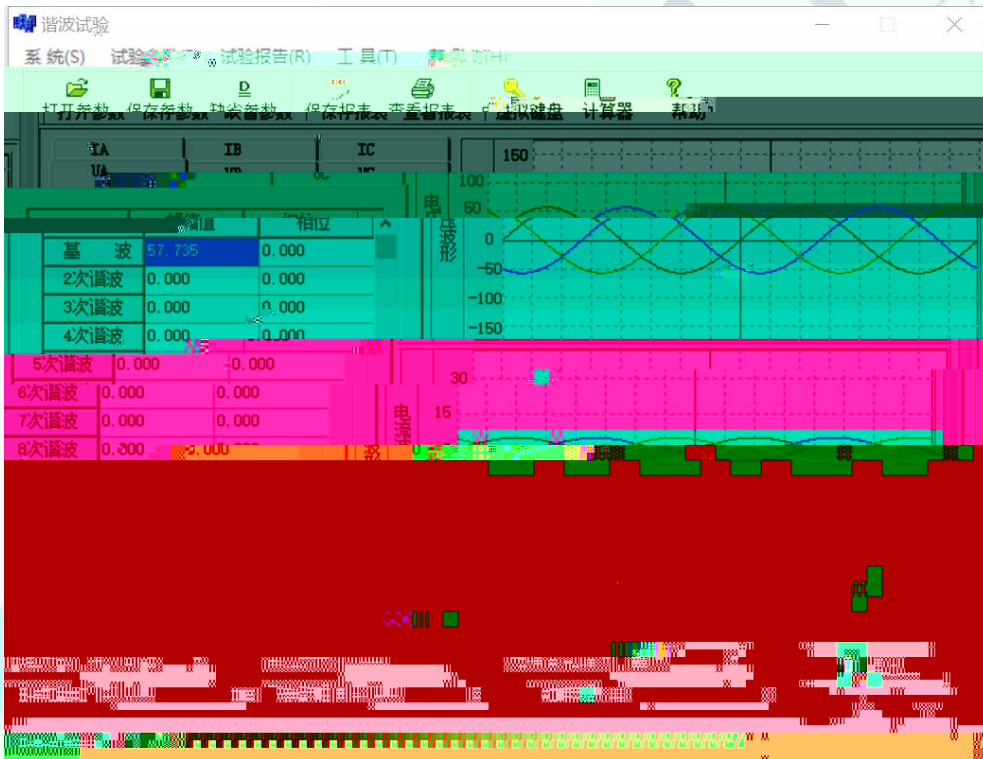

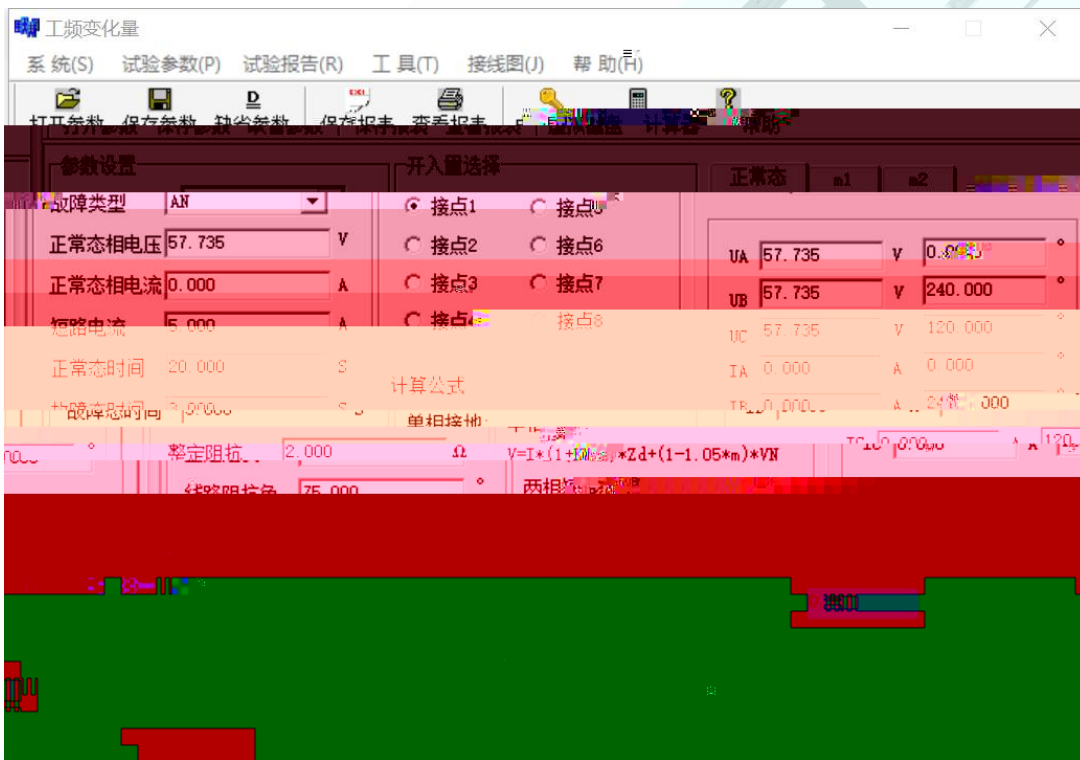

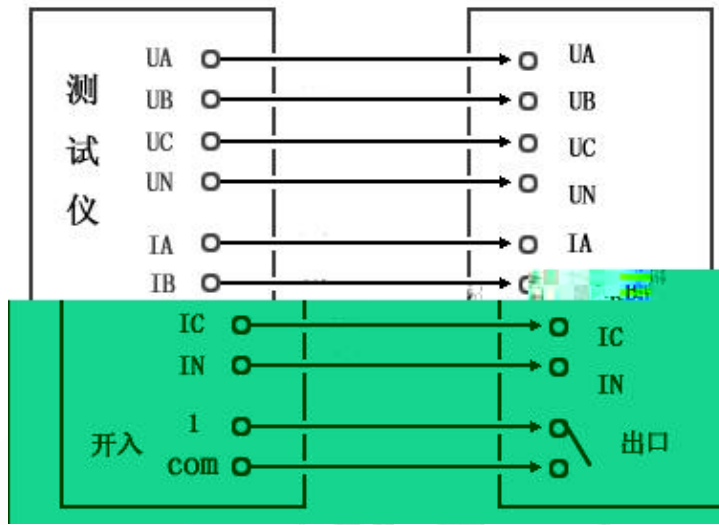

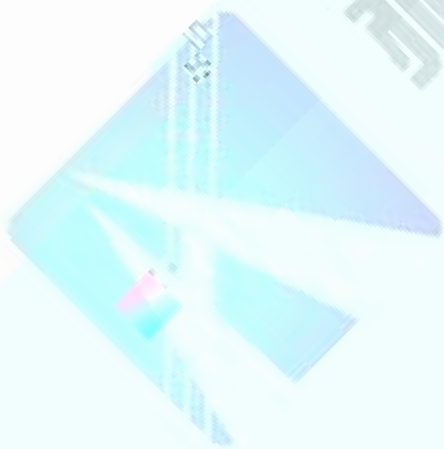
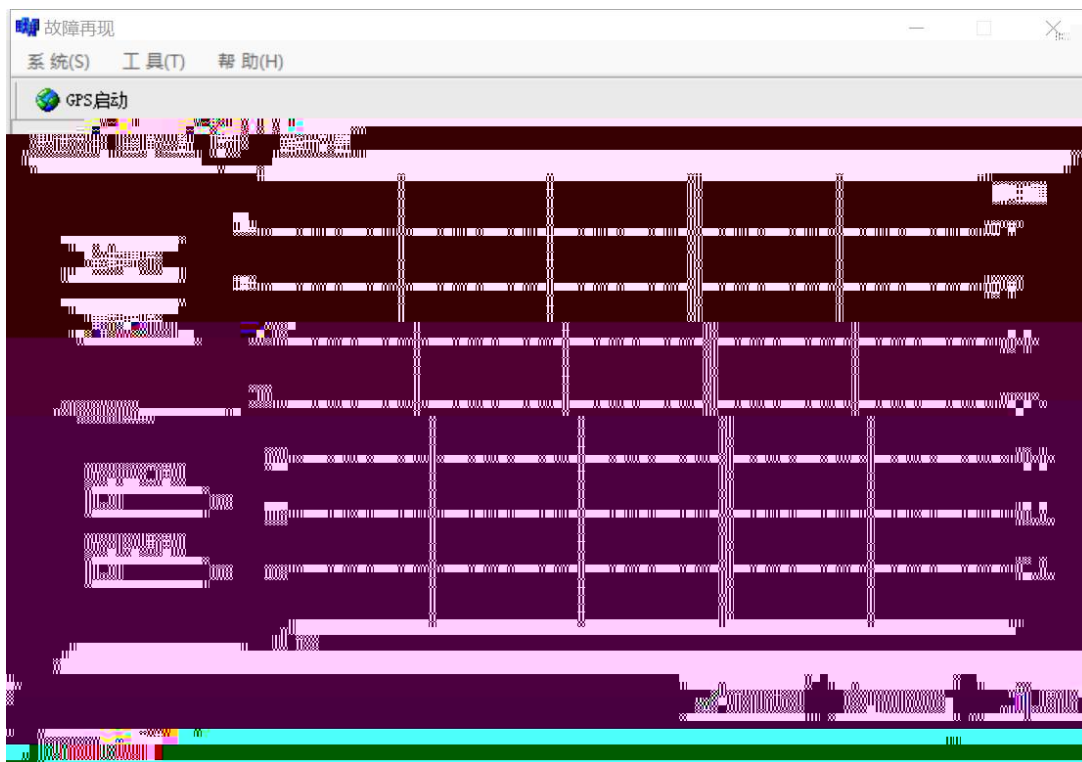

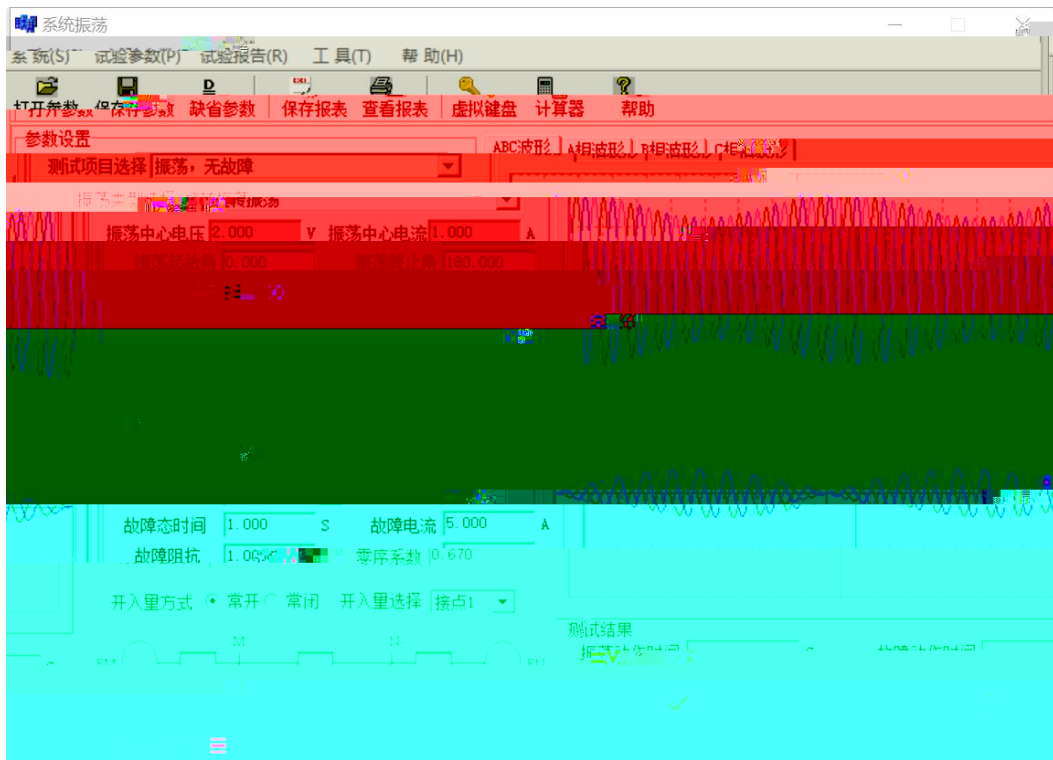



产品宗旨：技术领先，质量可靠，轻便易用

服务宗旨：快速响应，客户满意，超过期望

赫兹电力
HERTZ POWER

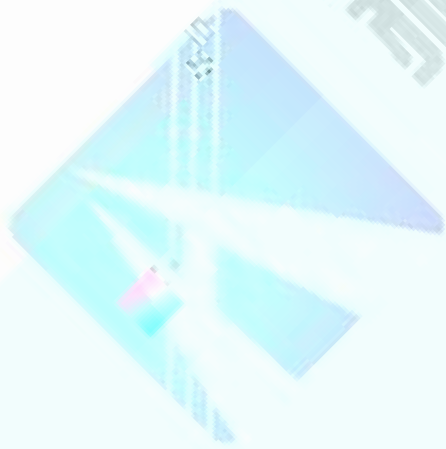

PREED

赫 电力

产品宗旨 技术领先, 质量可靠, 便易用
服务宗旨 快速响应, 客户满意, 服务周到

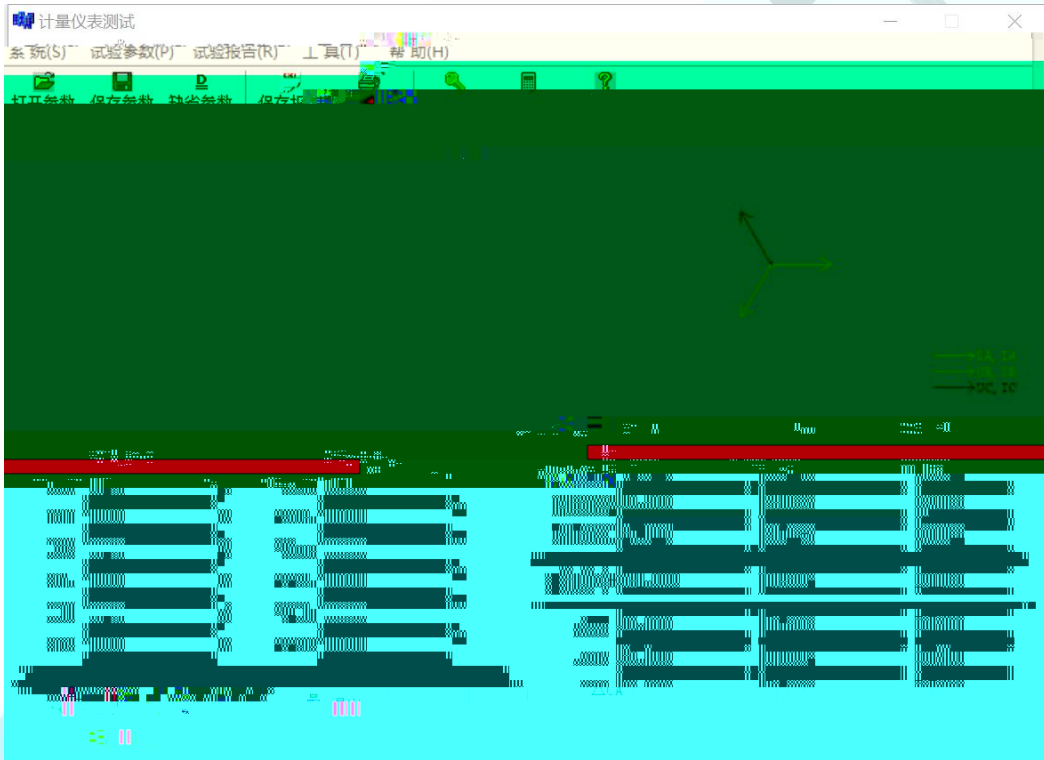

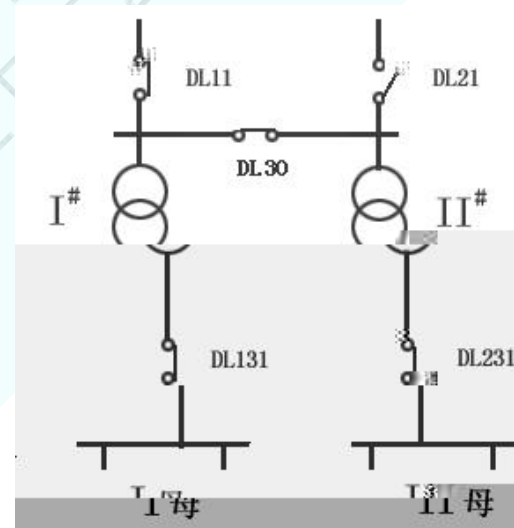
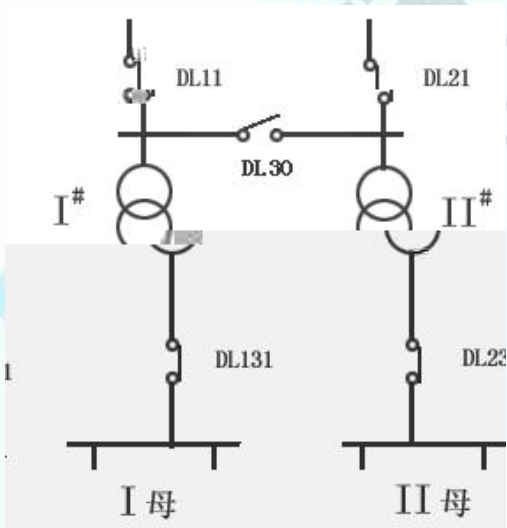
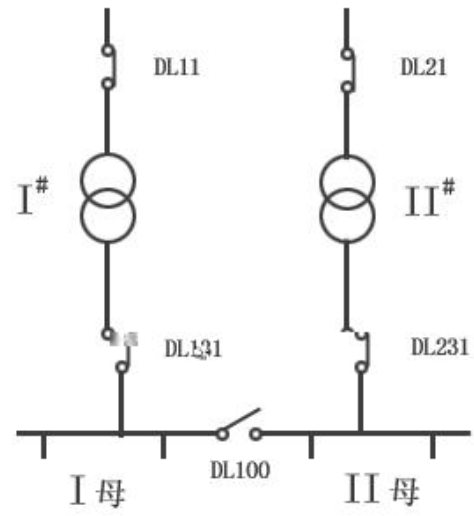
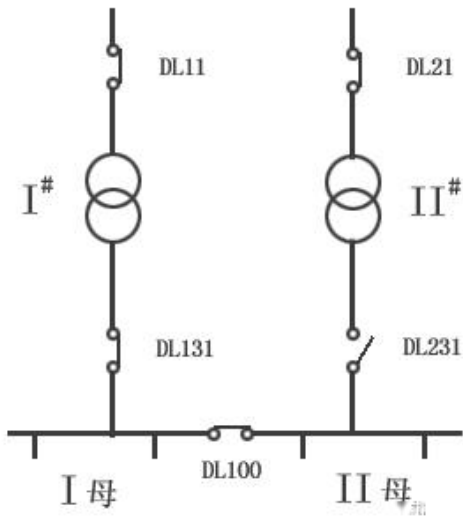



产品宗旨：技术领先，质量可靠，轻便易用

服务宗旨：快速响应，客户满意，超过期望

赫兹电力
HERTZ POWER

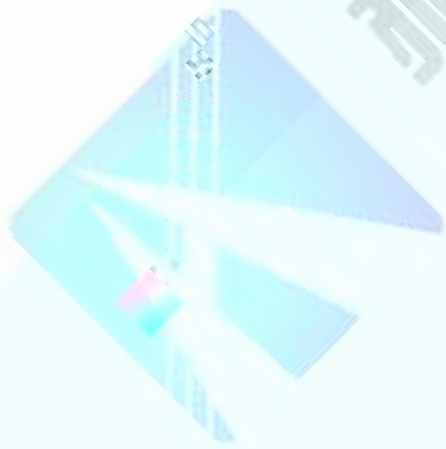

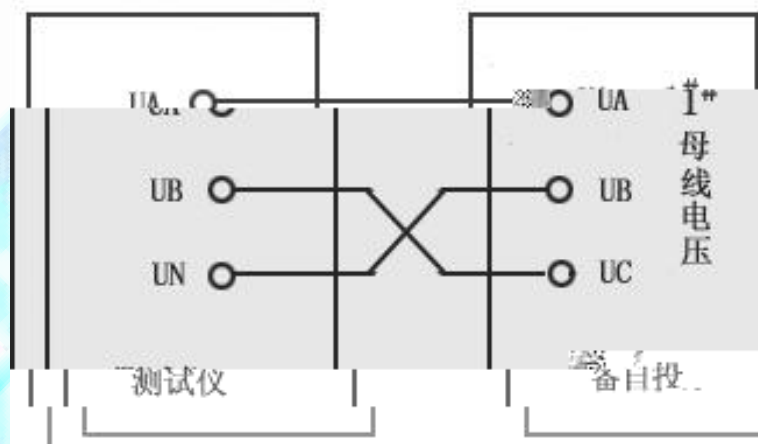
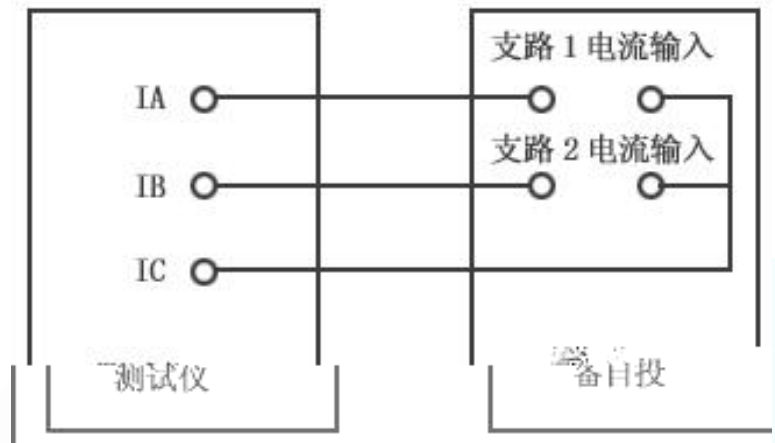

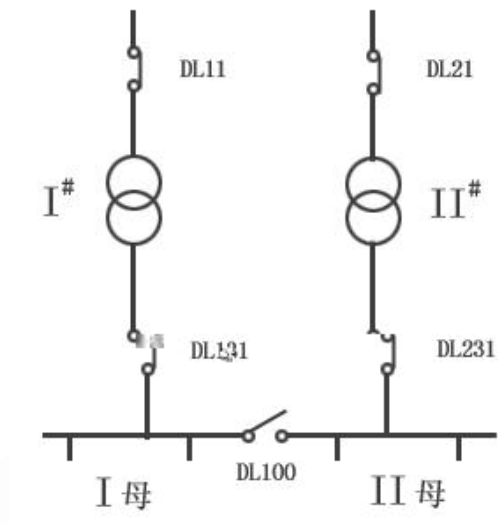



产品宗旨：技术领先，质量可靠，轻便易用

服务宗旨：快速响应，客户满意，超过期望

赫兹电力
HERTZ POWER

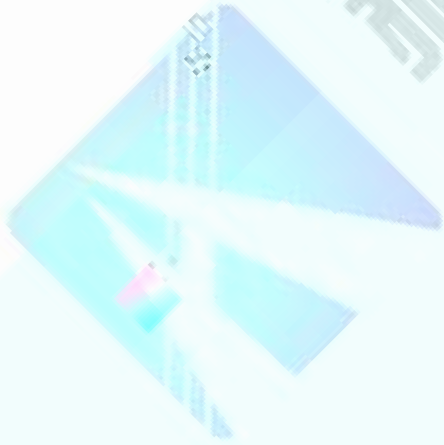

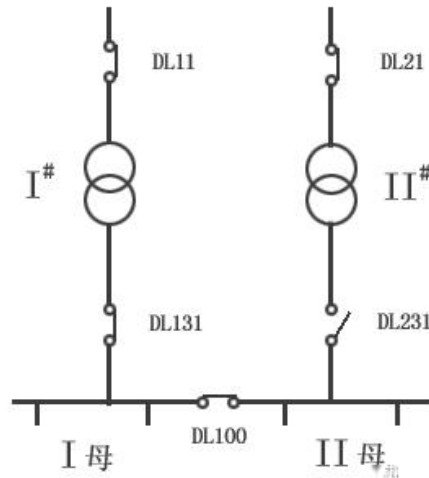

- 选中状态下的各相电压电流

UA	100.000	V	0.000
UB	100.000	V	60.000
UC	100.000	V	0.000
UX	100.000	V	60.000
IA	2.000	A	0.000
IB	0.000	A	-120.000
IC	0.000	A	120.000
IX	0.000	A	0.000

- 选中状态下的各相电压电流

UA	0.000	V	0.000
UB	0.000	V	60.000
UC	0.000	V	0.000
UX	0.000	V	60.000
IA	0.000	A	0.000
IB	2.000	A	-120.000
IC	0.000	A	120.000
IX	0.000	A	0.000

- 选中状态下的各相电压电流

UA	100.000	V	0.000
UB	100.000	V	60.000
UC	100.000	V	0.000
UX	100.000	V	60.000
IA	0.000	A	0.000
IB	2.000	A	-120.000
IC	0.000	A	120.000
IX	0.000	A	0.000



产品宗旨：技术领先，质量可靠，轻便易用
服务宗旨：快速响应，客户满意，超过期望

赫兹电力
HERTZ POWER

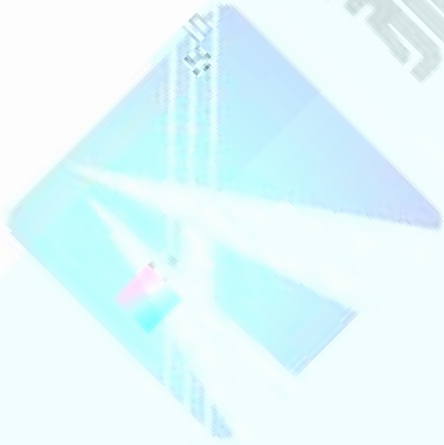

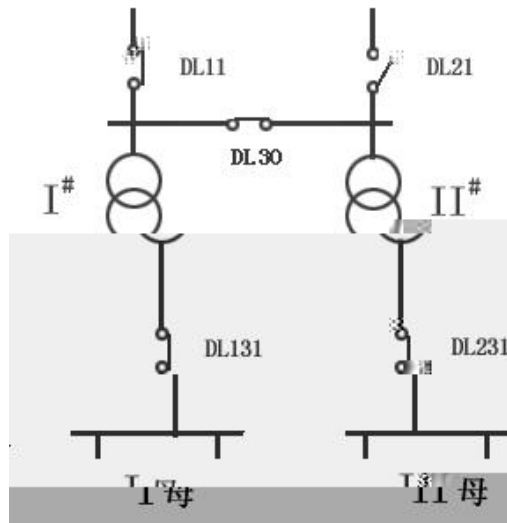

赫兹电力
HERTZ POWER

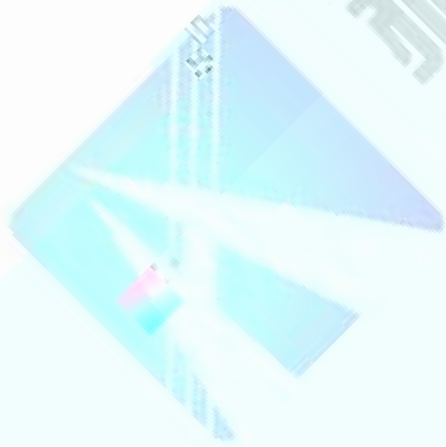



产品宗旨：技术领先，质量可靠，轻便易用

服务宗旨：快速响应，客户满意，超过期望

赫兹电力
HERTZ POWER

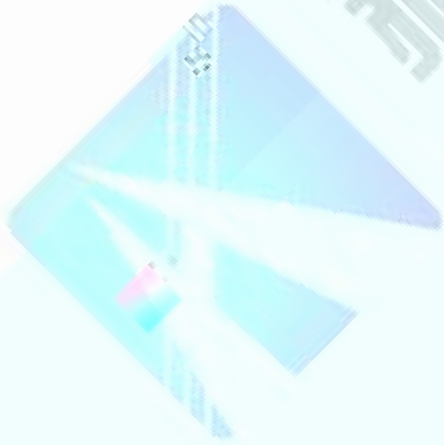

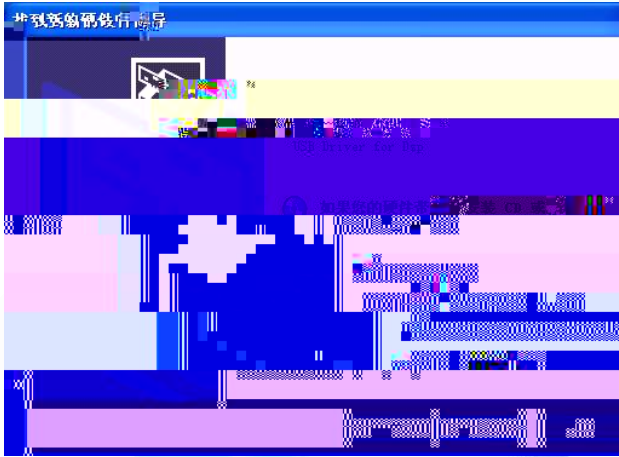
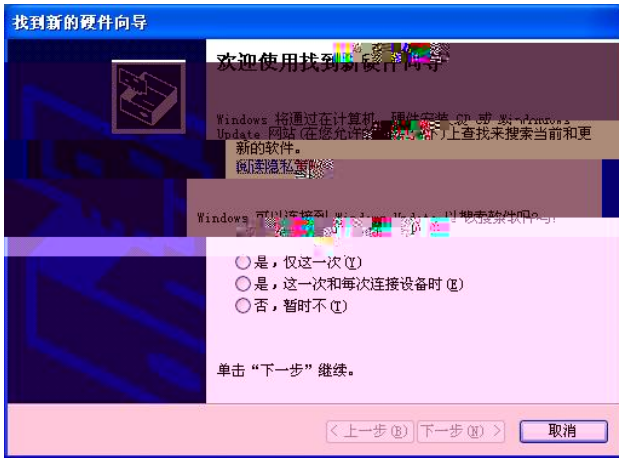

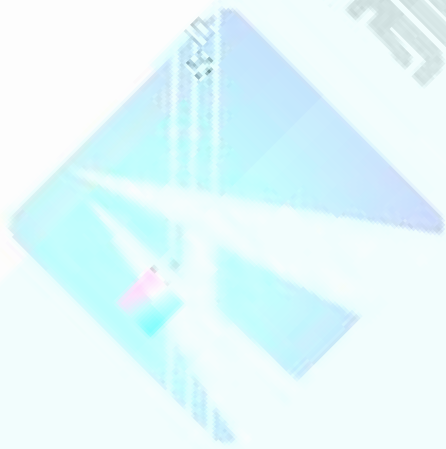



产品宗旨：技术领先，质量可靠，轻便易用
服务宗旨：快速响应，客户满意，超过期望

赫兹电力
HERTZ POWER

